



CLUB CODES AND REGULATIONS

©1989 - 2024

2024.0 EDITION ©

THIS BOOK IS AN OFFICIAL PUBLICATION OF THE NATIONAL AUTO SPORT ASSOCIATION.
ALL RIGHTS RESERVED.

NOTE- MID-SEASON UPDATES MAY BE PUBLISHED.

PLEASE NOTE THE VERSION NUMBER ABOVE.

THE CONTENTS OF THIS BOOK ARE THE SOLE PROPERTY OF THE NATIONAL AUTO SPORT ASSOCIATION. NO PORTION OF THIS BOOK MAY BE REPRODUCED IN ANY MANNER, ELECTRONICALLY TRANSMITTED, POSTED ON THE INTERNET, RECORDED BY ANY MEANS, OR STORED ON ANY MAGNETIC / ELECTROMAGNETIC STORAGE SYSTEM(S) WITHOUT THE EXPRESS WRITTEN CONSENT FROM THE NATIONAL EXECUTIVE DIRECTOR OF THE NATIONAL AUTO SPORT ASSOCIATION. NOTE- THE VERSION POSTED ON THE WEBSITE MAY BE PRINTED FOR PERSONAL USE.

National Auto Sport Association
National Office
7065 W Ann Rd. #130 - 432
Las Vegas, NV 89130
<https://DriveNASA.com>
510-232-NASA
510-277-0657 FAX

Author: Jerry Kunzman
Editors: Jim Politi and Bruce Leggett

TABLE OF CONTENTS

| | | |
|------------|--|----------|
| 1.0 | TERMINOLOGY AND DEFINITIONS | 3 |
| 1.1 | Activities | 3 |
| 1.1.1 | High Performance Driving Event (HPDE) | 3 |
| 1.1.2 | Driving School | 3 |
| 1.1.3 | Open Track | 3 |
| 1.1.4 | Competition | 3 |
| 1.1.5 | Time Trial / Time Attack | 3 |
| 1.1.6 | Other NASA Activities | 3 |
| 1.2 | Facility Terminology | 4 |
| 1.2.1 | Racetrack | 4 |
| 1.2.2 | Restricted Area | 4 |
| 1.2.3 | Re-Entry (Head of Pit lane) | 4 |
| 1.2.4 | Hot Pits | 4 |
| 1.2.5 | Paddock / Pre-Grid | 4 |
| 1.2.6 | Cold Pits | 4 |
| 1.2.7 | Pitlane | 4 |
| 1.2.8 | Aerial Photography | 4 |
| 1.3 | Membership Definitions | 4 |
| 1.3.1 | Member | 4 |
| 1.3.2 | Membership – Terms and Conditions | 4 |
| 1.3.3 | Membership - Associate | 5 |
| 1.3.4 | Member Car Club Insurance | 5 |
| 1.3.5 | Membership Renewal | 5 |
| 1.3.6 | Membership Revocation | 5 |
| 1.4 | Administrative Terms | 5 |
| 1.4.1 | National Appeals | 5 |
| 1.4.2 | Race Car / Competition Vehicle | 6 |
| 1.4.3 | Entrant | 6 |
| 1.4.4 | Participant | 6 |
| 1.4.5 | Waiver | 6 |
| 1.4.6 | Control / Race Control | 6 |
| 1.4.7 | Driver Review | 6 |
| 1.5 | Sponsors | 6 |
| 2.0 | OFFICIALS AND THEIR DUTIES | 7 |
| 2.1 | Purpose | 7 |
| 2.2 | All Officials- General Philosophy | 7 |
| 2.3 | Executive Administration | 7 |
| 2.3.1 | Cheif Executive Officer | 7 |
| 2.3.2 | National Chairman | 7 |
| 2.3.3 | Chief Divisional Director | 7 |
| 2.3.4 | Regional Director | 7 |
| 2.4 | Event Administration | 7 |
| 2.4.1 | Event Director | 7 |
| 2.4.2 | Chief Instructor | 8 |
| 2.4.3 | Registrars | 8 |
| 2.4.4 | Timing and Scoring | 8 |
| 2.4.5 | Paddock Marshal | 8 |
| 2.5 | Pace Car / Safety Car- Driver | 8 |

| | | |
|------------|--|-----------|
| 2.6 | Event Operations | 8 |
| 2.6.1 | Chief of Communications | 8 |
| 2.6.2 | Starter | 8 |
| 2.6.3 | Course Officials (Flaggers) | 8 |
| 2.6.4 | Violation Controller | 9 |
| 2.6.5 | Chief Steward | 9 |
| 2.6.6 | Pre-Grid Marshal | 10 |
| 2.6.7 | Re-Entry Marshal | 10 |
| 2.6.8 | Operating Steward (OS) | 10 |
| 2.6.9 | Chief Scrutineer | 10 |
| 2.6.10 | Tech Inspectors | 10 |
| 2.6.11 | Race Director | 10 |
| 2.7 | Officials / Rules Hierarchy | 10 |
| 2.8 | National Series Directors | 11 |
| 3.0 | <u>HPDE RULES AND REGULATIONS</u> | 14 |
| 3.1 | General Rules | 14 |
| 3.2 | Definition and Terms | 14 |
| 3.3 | Program Overview and Intentions | 14 |
| 3.4 | Eligibility Requirements | 14 |
| 3.5 | *Minors | 14 |
| 3.5.1 | **Addendum to Minors | 14 |
| 3.6 | Non-Eligibility / Non-Registered Drivers | 15 |
| 4.0 | <u>HPDE PARTICIPANT CONDUCT</u> | 16 |
| 4.1 | Participant Conduct - Expectations | 16 |
| 4.2 | Conduct of Guests and Crew | 16 |
| 4.3 | Property Damage | 16 |
| 4.4 | Disabled / Handicapped | 16 |
| 4.5 | HPDE Passenger Privileges | 16 |
| 4.6 | Responsibilities for Valuables | 17 |
| 4.7 | Alcoholic Beverages | 17 |
| 4.8 | Narcotics and Dangerous Drugs | 17 |
| 4.9 | Rain and Inclement Weather | 17 |
| 5.0 | <u>HPDE RULES OF THE PIT LANE AND PADDOCK</u> | 18 |
| 5.1 | Paddock Rules | 18 |
| 5.2 | Pets at the track | 18 |
| 5.3 | Loud Engines | 18 |
| 5.4 | Gas Cylinders | 18 |
| 5.5 | Bicycles, Skates, Moped, etc.- (PARENTS!): | 18 |
| 5.5.1 | Segway™ | 19 |

| | | |
|------------|--|-----------|
| 5.6 | Minimum Attire | 19 |
| 5.6.1 | Usage of Aerial Photography | 19 |
| 6.0 | HPDE COURSE CONDUCT | 20 |
| 6.1 | Purpose and Philosophy | 20 |
| 6.2 | Preparation for Course driving | 20 |
| 6.3 | Passing Rules | 20 |
| 6.4 | Rule Violations | 20 |
| 6.5 | Stopping On Course | 20 |
| 6.5.1 | Stopping in an Emergency | 20 |
| 6.6 | Counter-Course Driving | 21 |
| 6.7 | Spins or Off-Track Excursions | 21 |
| 6.8 | Body Contact | 21 |
| 6.9 | Post Accident Emergency Procedures | 21 |
| 6.10 | Post Accident Reporting | 21 |
| 7.0 | INSTRUCTIONS FOR HPDE, SCHOOL, AND OPEN TRACK FLAGS | 22 |
| 7.1 | Green Flag | 22 |
| 7.2 | Yellow Flag - Motionless | 22 |
| 7.3 | Yellow Flag - Waving | 22 |
| 7.4 | Double Yellow Flags | 22 |
| 7.5 | Black Flag - Open | 22 |
| 7.6 | Black Flag - Furled | 22 |
| 7.7 | Black Flag All - Waving | 22 |
| 7.8 | Checkered Flag | 23 |
| 7.9 | Red Flag | 23 |
| 7.10 | Blue Flag | 23 |
| 7.11 | Debris Flag | 23 |
| 7.12 | White Flag | 23 |
| 7.13 | Emergency Vehicle Flag | 23 |
| 7.14 | Mechanical Black Flag | 23 |
| 7.15 | Pace Car (with lights on) | 23 |
| 8.0 | INSTRUCTIONS FOR HPDE HAND SIGNALS | 24 |
| 8.1 | Slowing down | 24 |
| 8.2 | Passing signals | 24 |
| 8.3 | Flag Station Acknowledgement | 24 |

| | | |
|-------------|--|-----------|
| 9.0 | NASA INSTRUCTOR LICENSE | 25 |
| 9.1 | NASA Provisional Instructor License | 25 |
| 9.2 | NASA Instructor License Eligibility Guidelines | 25 |
| 9.3 | NASA Instructor License Renewal | 25 |
| 9.4 | Competition Licensing Instructors | 25 |
| 10.0 | NASA INSTRUCTOR PROGRAM | 26 |
| 10.1 | Purpose | 26 |
| 10.2 | DUTIES OF NASA INSTRUCTOR | 26 |
| 10.2.1 | Supervision of students | 26 |
| 10.2.2 | Schedule | 26 |
| 10.2.3 | Student Curriculum | 26 |
| 10.2.4 | Questionnaire | 26 |
| 10.2.5 | Classroom/clipboard session | 26 |
| 10.3 | REGULATIONS FOR NASA INSTRUCTORS | 26 |
| 10.3.1 | Rules Knowledge | 26 |
| 10.3.2 | Instructor IDs | 26 |
| 10.3.3 | Instructor's Vehicles | 27 |
| 10.3.4 | Vehicle Operation | 27 |
| 11.0 | HPDE TECHNICAL REQUIREMENTS | 28 |
| 11.1 | Purpose | 28 |
| 11.2 | Preparation Instructions | 28 |
| 11.3 | Required Safety Equipment - Driver | 28 |
| 11.4 | Vehicle Technical Regulations | 29 |
| 11.4.1 | Appearance | 29 |
| 11.4.2 | Wheels and Tires | 29 |
| 11.4.3 | Steering and Suspension | 29 |
| 11.4.4 | Engine Bay | 29 |
| 11.4.5 | Brakes | 29 |
| 11.4.6 | Disabled Drivers - Controls | 29 |
| 11.4.7 | Roll Bars | 29 |
| 11.4.8 | Seatbelts and Harnesses | 30 |
| 11.4.9 | Battery | 30 |
| 11.4.10 | Fuel Caps | 30 |
| 11.4.11 | Exposed Wires | 30 |
| 11.4.12 | Seats | 30 |
| 11.4.13 | Loose Objects | 31 |
| 11.4.14 | Car Numbers | 31 |
| 11.4.15 | Rearview Mirrors | 31 |
| 11.4.16 | Camera Mounts | 31 |
| 11.4.17 | Hoses Inside Cockpit | 31 |
| 11.4.18 | Lights | 31 |
| 11.4.19 | Tow Eyes | 31 |
| 11.4.20 | Mufflers: Sound Limit | 31 |
| 11.4.21 | Alcohol Injection | 32 |
| 11.4.22 | Exhaust Exit | 32 |
| 11.4.23 | Electric and Hybrid Powered Vehicles | 32 |
| 12.0 | COMPETITION ENTRY REGULATIONS | 34 |

| | | |
|--|---|-----------|
| 12.1 | Official Notice of Disclaimer | 34 |
| 12.2 | Participant Eligibility and Requirements | 34 |
| 12.3 | *Minors | 34 |
| 12.3.1 | **Addendum to Minors | 34 |
| 12.4 | Non-Eligibility / Non-Registered Drivers | 35 |
| <u>13.0 NASA PROVISIONAL LICENSE</u> | | 36 |
| 13.1 | Issuance of a NASA Provisional License | 36 |
| 13.1.1 | NASA licensing program: | 36 |
| 13.1.2 | SCCA Regional Licensing program: | 36 |
| 13.1.3 | NASA or SCCA Vintage Licensing program: | 36 |
| 13.1.4 | NASA or SCCA accredited racing school: | 36 |
| 13.1.5 | Provisional Licenses Completion: | 36 |
| 13.2 | Rookie Status | 37 |
| 13.2.1 | Rookie Markings | 37 |
| 13.2.2 | Rookie Plate | 37 |
| 13.3 | Provisional License Revocation | 37 |
| <u>14.0 NASA COMPETITION LICENSE</u> | | 38 |
| 14.1 | Issuance of NASA Competition License | 38 |
| 14.1.1 | NASA completed Provisional License holders: | 38 |
| 14.1.2 | FIA, SRO, SCCA, BMW Club, PCA license holders | 38 |
| 14.2 | Waiver of License Requirements | 38 |
| 14.3 | License Renewal/Expiration | 38 |
| 14.4 | Express Handling Fee | 38 |
| 14.5 | License Revocation or Suspension | 39 |
| 14.6 | False Information | 39 |
| 14.6.1 | Aliases | 39 |
| <u>15.0 REQUIRED SAFETY EQUIPMENT</u> | | 40 |
| 15.1 | Fire Extinguisher | 40 |
| 15.2 | Fire System | 40 |
| 15.3 | Fire Extinguisher / Fire System Required Decal | 40 |
| 15.4 | Fuel Cell / Tank | 40 |
| 15.4.1 | Installation | 41 |
| 15.4.2 | Rotary-molded cells | 41 |
| 15.4.3 | Fuel Cell for Alternative Liquid Fuels | 41 |
| 15.5 | Driver restraint system | 41 |
| 15.6 | Roll Cage | 44 |
| 15.6.1 | Purpose | 44 |
| 15.6.2 | Chassis Stiffening | 44 |
| 15.6.3 | Installation | 44 |
| 15.6.4 | Padding | 44 |
| 15.6.5 | Bends | 44 |
| 15.6.6 | Main Hoop | 44 |

| | | |
|--------------|--|-----------|
| 15.6.7 | Diagonal Brace | 44 |
| 15.6.8 | Forward Hoops (Option 1) | 44 |
| 15.6.9 | Halo Hoop (Option 2) | 45 |
| 15.6.10 | Front Hoop (Option 3) | 45 |
| 15.6.11 | Rear Braces (see diagram at the end of section) | 45 |
| 15.6.12 | Door Bars / Side Impact Protection | 45 |
| 15.6.13 | Mounting Points | 45 |
| 15.6.14 | Mounting Plates | 46 |
| 15.6.15 | Welds | 46 |
| 15.6.16 | Tube Structure Design / Body | 46 |
| 15.6.17 | Additional Reinforcement | 46 |
| 15.6.18 | Roll Cage Tubing Sizes | 47 |
| 15.6.19 | Bending Allowances | 47 |
| 15.6.20 | Inspection | 47 |
| 15.6.21 | Seat Back Support | 47 |
| 15.6.22 | Shoulder Harness Bar | 48 |
| 15.7 | Disability Operated - Controls | 51 |
| 15.8 | Master Switch | 51 |
| 15.9 | Steering Wheel Lock | 51 |
| 15.10 | Windows / Window Nets | 51 |
| 15.11 | Camera Mounts | 51 |
| 15.12 | Tow Eyes | 51 |
| 15.13 | Windshield / Sunroof Clips, Headlights | 52 |
| 15.14 | Hoses Inside Cockpit | 52 |
| 15.15 | Lights | 52 |
| 15.15.1 | Brake | 52 |
| 15.15.2 | Headlights | 52 |
| 15.15.3 | Rain Light | 52 |
| 15.16 | Driver's Seat | 52 |
| 15.16.1 | Racing Seat | 52 |
| 15.16.2 | Seat Mounting | 52 |
| 15.17 | Driver's Attire | 53 |
| 15.17.1 | Driving Suits | 53 |
| 15.17.2 | Underwear | 53 |
| 15.17.3 | Helmet | 53 |
| 15.17.4 | Gloves | 53 |
| 15.17.5 | Eye and Face protection | 53 |
| 15.17.6 | Shoes | 53 |
| 15.17.7 | Socks | 53 |
| 15.17.8 | Head and Neck Restraint | 54 |
| 15.17.9 | Head Restraint – Side Impact | 54 |
| 15.18 | Engine Coolant | 55 |
| 15.19 | Alcohol Injection (where permitted by class rules) | 55 |
| 15.20 | Ballast | 55 |
| 15.21 | Exhaust Exit | 55 |
| 15.22 | Mandatory Video Camera | 55 |
| 15.23 | Fuel Caps | 56 |
| 15.24 | Non-NASA-classed Vehicles Safety Equipment Requirements | 56 |

| | | |
|-------------|--|-----------|
| 15.25 | Electric and Hybrid Powered Vehicles | 56 |
| 16.0 | VEHICLE SAFETY INSPECTION | 57 |
| 16.1 | Competition Vehicle Logbook | 57 |
| 16.2 | Annual Safety Inspection | 57 |
| 16.2.1 | Re-Inspection- Alteration/Damage | 57 |
| 16.2.2 | Emergency Exit Time | 57 |
| 16.3 | Safety Inspection at Each Event | 57 |
| 17.0 | VEHICLE LEGALITY INSPECTION | 59 |
| 17.1 | Impound | 59 |
| 17.2 | Post Race / Qualifying Legality Inspection | 59 |
| 17.3 | Disassembly | 59 |
| 17.4 | Confidentiality | 59 |
| 17.5 | Protests, Request for Action, and Appeals | 59 |
| 17.5.1 | Protests | 59 |
| 17.5.2 | Request For Action (RFA) | 60 |
| 17.5.3 | Appeals - Regional | 60 |
| 17.5.4 | Appeals - Executive | 60 |
| 17.6 | Bad Faith Protests | 60 |
| 17.7 | Class Rule Compliance | 61 |
| 17.8 | Minimum Weight | 61 |
| 18.0 | GENERAL COMPETITION VEHICLE RULES | 62 |
| 18.1 | VEHICLE APPEARANCE | 62 |
| 18.1.1 | Car Numbers and Class Designation | 62 |
| 18.1.2 | Advertisements and Graphics | 62 |
| 18.1.3 | Car Condition | 62 |
| 18.1.4 | Loss of bodywork | 62 |
| 18.2 | Mufflers: Sound Limit. | 62 |
| 18.3 | Permitted Fuel | 63 |
| 18.3.1 | Fuel Additives | 63 |
| 18.4 | Engine Paint and Coatings | 63 |
| 18.5 | Battery | 63 |
| 18.6 | Exposed Wires | 63 |
| 18.7 | Tire Grooving / Shaving | 63 |
| 18.8 | Objects Interfering with Safe Operation | 63 |
| 19.0 | FLAGS, SIGNALS, AND COMMUNICATION | 64 |
| 19.1 | Purpose and Methods | 64 |
| 19.2 | Signal (i.e. flag) Categories | 64 |
| 19.3 | Flag Descriptions and Meanings | 64 |

| | | |
|--------------|--|-----------|
| 19.3.1 | Green Flag | 64 |
| 19.3.2 | Restart Flags | 64 |
| 19.3.3 | Checkered Flag | 65 |
| 19.3.4 | Yellow Flag - Standing | 65 |
| 19.3.5 | Yellow Flag - Waving | 65 |
| 19.3.6 | Double Yellow Flags | 65 |
| 19.3.7 | Black Flag - Open | 65 |
| 19.3.8 | Black Flag - Furled | 66 |
| 19.3.9 | Black Flag All - Waving | 66 |
| 19.3.10 | Red Flag | 66 |
| 19.3.11 | Blue Flag | 66 |
| 19.3.12 | Debris Flag / Surface Flag | 66 |
| 19.3.13 | White Flag- Standing | 67 |
| 19.3.14 | White Flag- Waving | 67 |
| 19.3.15 | Emergency Vehicle Flag | 67 |
| 19.3.16 | Emergency Scene | 67 |
| 19.3.17 | Mechanical Black Flag | 67 |
| 19.3.18 | Green Flag with Waving Yellow | 67 |
| 19.4 | Lights and Meanings | 68 |
| 19.4.1 | Pace Car / Safety Car (with lights on) | 68 |
| 19.4.2 | Director or Administration (lights on or off) | 68 |
| 19.4.3 | Tow, Safety, and Fire Trucks OR | 68 |
| 19.4.4 | Course Lights | 68 |
| 19.5 | HAND SIGNALS | 68 |
| 19.5.1 | Slowing Down - driver | 68 |
| 19.5.2 | Passing Signals - driver | 68 |
| 19.5.3 | Flag Station Acknowledgment | 68 |
| 19.5.4 | Other Hand Signals - driver | 68 |
| 19.6 | Sign Boards | 69 |
| 19.6.1 | Leading Vehicle Pace Car | 69 |
| 20.0 | COMPETITION FORMAT | 70 |
| 20.1 | Race Length | 70 |
| 20.2 | Qualifying and Starting Order | 70 |
| 20.2.1 | Random Grid / Special Cases | 70 |
| 20.2.2 | Grid Adjustments, Inverts, Draws, etc. | 70 |
| 20.2.3 | Lack of Qualifying Times | 70 |
| 20.2.4 | Teammates and Vehicle Substitutions | 70 |
| 20.3 | Grid Formation | 70 |
| 20.3.1 | Pre-Grid | 70 |
| 20.3.2 | Choosing the pole | 71 |
| 20.4 | Warm-up Laps | 71 |
| 20.5 | The Start | 71 |
| 20.5.1 | Rolling Start / Flying Start | 71 |
| 20.5.2 | Standing Start | 71 |
| 20.6 | Split start | 71 |
| 20.7 | Timed Split Start | 72 |
| 20.8 | Flagman Timed Start (split or not) | 72 |
| 20.9 | Light System Timed Start (split or not) | 72 |
| 20.10 | Start/ Restart Jumping | 72 |

| | |
|---|-----------|
| 20.11 Pace Car procedures | 72 |
| 20.11.1 Pace Car Restart – General | 72 |
| 20.12 Restarts and Resumptions | 72 |
| 20.12.1 Full Course Yellow / Pace Car Procedures | 73 |
| 20.12.2 Red Flag | 73 |
| 21.0 SCORING AND RACE RESULTS | 74 |
| 21.1 Adjustments by The Race Director | 74 |
| 21.2 Race Starter | 74 |
| 21.3 Race Finisher | 74 |
| 21.4 Winner | 74 |
| 21.5 Official Results | 74 |
| 21.6 Dead Heats | 74 |
| 21.7 Lap Record | 74 |
| 21.8 Timing and Scoring Transponders | 74 |
| 21.8.1 Ensuring Proper Functionality of the Transponder | 75 |
| 21.9 Finish / Starting Line | 75 |
| 22.0 CALCULATING SEASON POINTS | 76 |
| 22.1 Season Points System | 76 |
| 22.1.1 Default Season Points System | 76 |
| 22.2 Dropping Race Scores | 76 |
| 22.2.1 Default Points Drop System | 76 |
| 22.3 Season Points- Tie | 76 |
| 22.4 Team Formation | 76 |
| 22.4.1 Intent | 77 |
| 22.4.2 Declaration | 77 |
| 22.4.3 Points Tally | 77 |
| 22.4.4 Restrictions | 77 |
| 22.4.5 Privateer Runs | 77 |
| 22.5 Fun Runs | 77 |
| 22.6 Non-Points Runs | 77 |
| 22.7 National Championship | 78 |
| 23.0 PARTICIPANT CONDUCT | 79 |
| 23.1 Participant Conduct - Expectations | 79 |
| 23.1.1 Good Sportsmanship | 79 |
| 23.1.2 Unsportsmanlike Conduct | 79 |
| 23.1.3 Knowledge and Possession of the Rules | 79 |
| 23.1.4 Meeting Attendance | 79 |
| 23.2 Conduct of Guests and Crew | 79 |
| 23.3 Medical Conditions | 80 |
| 23.4 Pregnant Drivers | 80 |

| | | |
|-------------|--|-----------|
| 23.5 | Disabled / Handicapped | 80 |
| 23.6 | Responsibilities for Valuables | 80 |
| 23.7 | Alcoholic Beverages | 80 |
| 23.8 | Narcotics and Dangerous Drugs | 80 |
| 23.9 | Rain and Inclement Weather | 80 |
| 23.10 | NASA Suit Patch | 80 |
| 24.0 | RULES OF THE PIT LANE AND PADDOCK | 81 |
| 24.1 | Paddock Rules | 81 |
| 24.2 | Pets at the track | 81 |
| 24.3 | Loud Engines | 81 |
| 24.4 | Gas Cylinders | 81 |
| 24.5 | Bicycles, Skates, Moped, etc. | 81 |
| 24.5.1 | Segway™ | 81 |
| 24.6 | Minimum Attire | 82 |
| 24.7 | Overshooting the Pits | 82 |
| 24.8 | Endurance racing | 82 |
| 25.0 | ON COURSE CONDUCT | 83 |
| 25.1 | Flag Observance | 83 |
| 25.2 | Passengers | 83 |
| 25.3 | Rough, Careless, and Irresponsible Driving | 83 |
| 25.4 | Rules for Overtaking | 83 |
| 25.4.1 | Passing General | 83 |
| 25.4.2 | Punting / Passing in Corners | 83 |
| 25.4.3 | Right to the Line | 83 |
| 25.4.4 | Blocking | 83 |
| 25.5 | Yellow Flag- Passing | 84 |
| 25.6 | Off-course Excursions | 84 |
| 25.7 | Post Accident Reporting | 84 |
| 25.8 | Counter-Course Driving | 84 |
| 25.9 | Stopping On Course | 84 |
| 25.9.1 | Stopping in an Emergency | 85 |
| 25.10 | Crashes | 85 |
| 25.11 | Heating of Tires | 85 |
| 26.0 | APPENDIX A | 86 |
| 27.0 | APPENDIX B | 94 |
| 27.1 | Purpose and Intent | 94 |

| | | |
|--------------|--|------------|
| 27.2 | Format | 94 |
| 27.3 | Data Collection | 94 |
| 27.4 | Definitions | 94 |
| 27.4.1 | Body Contact | 94 |
| 27.4.2 | Damage | 94 |
| 27.4.3 | Course Deviation | 94 |
| 27.5 | Decision Making Process: | 94 |
| 27.6 | Evidence | 95 |
| 27.7 | Finding Fault | 95 |
| 27.8 | The Melee' | 95 |
| 27.9 | The Collection | 95 |
| 27.10 | The Punt | 95 |
| 27.10.1 | The Punt (exceptions) | 96 |
| 27.11 | Issuing Penalties | 96 |
| 27.12 | Driver's Points System | 96 |
| 27.12.1 | Point Limit- Annual | 97 |
| 28.0 | APPENDIX C | 98 |
| 28.1 | Definitions and References | 98 |
| 28.1.1 | 'IMSA' | 98 |
| 28.1.2 | 'SCCA' | 98 |
| 28.1.3 | SRO | 98 |
| 28.1.4 | 'PSR' | 98 |
| 28.1.5 | 'FIA'98 | |
| 28.1.6 | 'Splitter' | 98 |
| 28.1.7 | 'Air Dam' | 98 |
| 28.1.8 | 'Group or Type' | 98 |
| 28.1.9 | 'Wheel' / 'Tire' / 'Rim' | 98 |
| 28.1.10 | Specified Measurement | 98 |
| 28.1.11 | Tolerances | 99 |
| 28.1.12 | Telemetry | 99 |
| 28.2 | Disqualification "DQ" | 99 |
| 28.2.1 | DQ – Not Droppable | 99 |
| 29.0 | APPENDIX D | 100 |
| 29.1 | Head and Neck Restraint Systems | 100 |
| 29.1.1 | General | 100 |
| 29.1.2 | Installation and Replacement | 100 |

GENERAL PREFACE

Official Notice of Disclaimer

NASA makes an effort to provide participants with a relatively safe environment for everyone involved. Despite strict rule enforcement and strict rule adherence, all participants must be aware that their mere presence at an event presents a chance of becoming critically or fatally injured, even by no fault of their own. These rules do not guarantee or imply that injuries or death will not occur. All event attendees agree to assume the risk of being injured or killed by the negligence and/or gross negligence of others. If there are any questions or problems with these rules and regulations, it is the participant's responsibility to immediately contact the National Auto Sport Association (NASA) office before entering an event facility. NASA, 7065 W Ann Rd. #130 – 432, Las Vegas, NV 89130 / (510) 232-6272.

Safety Hazards

It is the responsibility of each event attendee to inspect and analyze **all** aspects related to the facility, rules, regulations, and/or instructions pertaining to the event (whether written or verbally stated). The event attendee is required to notify a NASA Official, without delay, of anything that appears to be a potential safety hazard. Failure to comply with this rule will be cause for permanent ejection from all NASA sanctioned activities, nationwide. Additionally, everyone involved should consider that no activity, facility, or system is 100% perfectly safe, despite all best efforts. Therefore, each participant is hereby notified that grave and unforeseen danger may exist in any activity, at any event, automotive related or otherwise.

MISSION and PURPOSE

National Auto Sport Association: Mission Statement

National Auto Sport Association, 7065 W Ann Rd. #130 – 432, Las Vegas, NV 89130 is a sanctioning body created to promote amateur and professional motorsports activities throughout the United States. The National Auto Sport Association (NASA) also serves to conduct, supervise, sanction, and organize amateur and professional motor racing and work in association with other motorsports organizations, striving for the betterment of all aspects of motorsports.

Definition and Purpose of the *Club Codes and Regulations (CCR)*

The National Auto Sport Association (NASA) has established this publication, known as the *Club Codes and Regulations (CCR)*, in order to set standards, rules, and guidelines that will function to govern NASA sanctioned motorsports activities in order to help promote safety and fairness in competition. The term CCR includes the appendices to the NASA *Club Codes and Regulations*, published addendums, and published rule updates found in *Speed News*, the official National publication of the National Auto Sport Association.

NOTATIONS:

THIS NOTATION

[Ref:(x.y.z)]

INDICATES:

“In reference to rules found in Section x.y.z of this publication.” The “x.y.z” should be an active hyperlink in the electronic version of this publication. Simply click on the notation.

|| SIGNIFIES CHANGES

GENERAL RULES AND DEFINITIONS

1 Terminology and Definitions

The following nomenclature, definitions, and abbreviations shall be used in this publication and any glossary, appendices, addendums, updates, entry forms, acceptance letters, and general use, wherever applicable. Terms, phrases, abbreviations, and proper names that appear in any official NASA publication that are not defined or specified in any other NASA official publication shall be considered commonly known in the context of motorsports and/or pertaining to automobiles. It is the responsibility of the entrants, drivers, participants, and competitors involved to educate themselves as to the appropriate meaning of any aforementioned items when viewed in the context of their activity or sport. If an official clarification is needed, it is solely the competitor's responsibility to contact the NASA National office for a written statement of definition.

1.1 Activities

1.1.1 High Performance Driving Event (HPDE)

The terms "School," "Driving School" [Ref:(1.1.2)], "Open Track" [Ref:(1.1.3)], Time Trial, Drifting, and Time Attack may be used interchangeably in this publication, except as where noted. Often times, all five terms are "generically" referred to as a "High Performance Driving Event" or (HPDE). It is intended to be used by the participants [Ref:(1.4.4)] for the enjoyment of driving their vehicles, and for the improvement of the driving skills in the hopes of becoming a safer driver. "Hyper-Drives" are the same as an HPDE but usually consist of just one session. This activity is usually used as an introduction into HPDE.

1.1.2 Driving School

The term "Driving School" refers to a NASA sanctioned and supervised driving event that includes basic instruction for beginners.

1.1.3 Open Track

The term "Open Track" refers to a NASA sanctioned and supervised HPDE event where mixed levels of drivers may participate in the same group.

1.1.4 Competition

Any speed contest, where more than one (1) vehicle is on course at the same time, using predetermined rules specifying a format where participants [Ref:(1.4.4)] are scored based on their performance, and recognition is given to the top finishers. "Race" and "Competition" may be used interchangeably within the context of this, and other related NASA publications, unless otherwise clarified.

1.1.5 Time Trial / Time Attack

This is competition against the clock. Vehicles must meet the minimum standard for HPDE. This may be run one vehicle at a time or have multiple vehicles on track together. Handicapped Pro Racing (HPR) series is a form of NASA time Trial.

1.1.6 Other NASA Activities

NASA offers a wide variety of driving programs throughout the United States including rally cross, rally sprint, circle track racing, hill climbs, NASA-X (autocross), drag races, open road races, TT (Time Trial), NASA Car Control Clinics, and more. Not all NASA Regions offer all these types of events. The rulebooks and descriptions are available from the national office and can be found online at <https://DriveNASA.com>.

GENERAL RULES AND DEFINITIONS

1.2 Facility Terminology

1.2.1 Racetrack

The racetrack is defined as the actual racing surface where no speed limit exists and is deemed a hazardous and restricted area [Ref:(1.2.2)] during events.

1.2.2 Restricted Area

Any area that is off limits to the general public is considered to be a restricted area. Restricted areas may typically include, but are not limited to, the paddock [Ref:(1.2.5)], the racetrack [Ref:(1.2.1)], surrounding hillsides and terrain, and the pit lane.

1.2.3 Re-Entry (Head of Pit lane)

Re-Entry is the exit of the hot pits leading onto the racetrack.

1.2.4 Hot Pits

The staging lane leading to Re-Entry [Ref:(1.2.3)] serves to refuel (when permitted), adjust, or repair a car during a session. The hot pits are considered part of the race track whether there is an imposed speed limit or not.

1.2.5 Paddock / Pre-Grid

The general term used to describe the allowed areas for the participants to park their vehicles, trucks, trailers, and motorhomes. This area is also used for repairing and preparing the vehicles between on-track sessions. Part of the paddock should serve as Pre-grid, where vehicles line up in to get on track for the next session.

1.2.6 Cold Pits

This is part of the pit lane that is where equipment is stored and is usually delineated by markers or a wall. The cold pits are a restricted area.

1.2.7 Pitlane

The pitlane is the entire area of the hot pits and the cold pits combined.

1.2.8 Aerial Photography

Aerial photography is defined as the action or procedure of taking photographic or video images by any aircraft including remote control flying objects commonly known as a “drones.”

1.3 Membership Definitions

1.3.1 Member

A person that has paid the membership fee within the last 12 months and 1) the person does not have any outstanding debts owed to NASA, any of its region, or any NASA sanctioned organization, affiliate, or sponsor and 2) the person is not currently under membership suspension with NASA, any of its regions, or any NASA sanctioned organization.

1.3.2 Membership – Terms and Conditions

NASA offers a National Membership Program, which means that one membership fee provides the member the opportunity to participate in any NASA sanctioned event anywhere in the country. The number shown on the card indicates the NASA Identification Number (membership number). A membership is valid through the expiration date indicated on the card image. All regular members in good standing [Ref:(1.3.1)] will receive *Speed News*, the official national publication of NASA.

GENERAL RULES AND DEFINITIONS

Additionally, in exchange for being allowed entry into a facility or access to any other location where a NASA event is taking place all members and attendees at any NASA event agree to allow NASA and their sponsors and/or marketing partners to use their name and / or likeness of themselves and their guests while attending NASA events for marketing and promotional purposes.

All members agree to accept occasional announcements pertaining to NASA related activities or offers via mail or email. Note: NASA does not sell, lend, or give-away any information about any member to sources outside of NASA (except to authorities upon demand) for any commercial purpose. Furthermore, all NASA members agree that any and all video footage and / or still photographs may be held by the NASA administration for certain purposes such as accident investigation.

In exchange for being allowed entry into a facility or access to any other location where a NASA event is taking place, all members and all attendees at NASA events agree that NASA owns and retains all rights and copyrights to all images and sound recordings obtained at NASA events, captured by any form of recording device, using any media such as (but not limited to) film, magnetic tapes, memory cards, and hard disk drives, unless superseded by written contract.

1.3.3 Membership - Associate

All of the members of any NASA sanctioned car club will automatically each be given associate membership status, thus making them eligible to participate in any NASA event anywhere in the country. This membership has all the same privileges as a regular membership however, no membership card is issued to associate members because their own club's membership card will be recognized. Only the national office may grant associate member privileges.

1.3.4 Member Car Club Insurance

A NASA sanctioned club may, at its option, be allowed to purchase Commercial General Liability insurance, Autocross insurance, and many other types of insurance that are very hard for a small club to afford. This insurance is available because NASA owns an annual policy, which is normally cost prohibitive for smaller sized organizations.

1.3.5 Membership Renewal

A member may renew at any time. However, the national office must receive a renewal fee (equal to the amount of the membership fee, unless otherwise published) by the indicated expiration date to ensure that no issues of the monthly publication will be missed. If a member is found to have participated in an event where membership is required, and that person has allowed their current membership status to expire (as defined in this section), that person will be subject to harsh penalties, including the possibility of indefinite expulsion.

1.3.6 Membership Revocation

NASA is a private club. NASA reserves the right to revoke or deny membership to any person. Upon revocation or denial, NASA may, at its discretion inform other clubs and sanctioning bodies of such revocation.

1.4 Administrative Terms

1.4.1 National Appeals

In cases where penalties and/or disciplinary action has been taken against a NASA member in good standing by an Event Director [Ref:(2.4.1)] or a Regional Director [Ref:(2.3.4)], that member has a right to make an appeal to the Chief Executive Officer [Ref:(2.3.1)], providing that the member complies with the applicable portions of the CCR Appeals Section #17.5.4 and that appeal is not prohibited by any applicable class rules.

GENERAL RULES AND DEFINITIONS

1.4.2 Race Car / Competition Vehicle

For the purposes of this publication, the terms “race car” and “competition vehicle” may be used interchangeably, unless otherwise specified. Generally speaking, both terms refer to any four wheeled, motorized vehicle possessing adequate safety equipment to meet the standards for a given type of contest. This does not imply that every participating vehicle meeting this definition is engaging in a contest. This section does not change any part of the definition of the term (or any similar term): “a vehicle that was designed principally for use on public roads or highways.”

1.4.3 Entrant

An entrant is any person that is registered as a driver for each event.

1.4.4 Participant

A participant is any of the following:

1. Any person, entering a restricted area during the event hours, possessing the proper wristband or credentials, if required, is considered to be a participant.
2. All entrants of each event are considered to be participants from the time that they enter the facility on the day of the event until they are finished with all activities related to the day’s event.
3. Any person that is, or will be, engaging in any physical activity pertaining to the event, including but not limited to, performing (or assisting in) work on vehicles and/or machinery, or using any tools during the event hours as defined by the published schedule.
4. Any NASA authorized members of the press, photographers, and television crew during the course of their duties.

1.4.5 Waiver

The term “waiver” refers to the NASA issued participant liability release, unless otherwise stated in context. All participants must sign and submit a waiver to Registration and/or to track/gate/security personnel [Ref:(2.4.3)] before any participation.

1.4.6 Control / Race Control

“Control” refers to the collective set of Officials that are in charge of the full course conditions, controlling the scheduled activities, maintaining a written record of incidents, communicating with each turn station, dispatching the emergency crews, and function as the central hub of information distribution as needed. Control is typically staffed with the Chief of Communications [Ref:(2.6.1)], a Violation Controller [Ref:(2.6.4)], an Operating Steward [Ref:(2.6.8)], and the Race Director [Ref:(2.4.1)]. See “OFFICIALS AND THEIR DUTIES” Section [Ref:(2)].

1.4.7 Driver Review

The Race Director shall have the power to convene a meeting to review a driver’s conduct, car legality, driving record, or other such matters. Such a meeting shall have the power to review eyewitness’ testimonies and the driver’s previous history in order to invoke penalties.

1.5 Sponsors

Sponsors offering cash or prizes to the competitors in exchange for services, such as advertising, are considered to be independent contractors. Each competitor that chooses to participate in a contingency award program accepts liability and responsibility for collecting his/her prize(s) or prize money. NASA makes no claims and takes no responsibility for said sponsors and makes no guarantee or warranties (implied or otherwise) in any regards. Competitors that wish to participate may be required to register directly with the sponsor and are solely responsible for collecting their prizes or prize money.

GENERAL RULES AND DEFINITIONS

2 OFFICIALS AND THEIR DUTIES

2.1 Purpose

The purpose of this section is to provide participants with a better understanding for the nomenclature used concerning event Officials, their titles, and a brief related description. It should be noted, that nothing in this section constitutes a rule of any kind, nor makes any guarantees of any type, since this is simply a guide to aide in the understanding of terms.

2.2 All Officials- General Philosophy

All Officials shall be friendly and courteous to all NASA participants. Participants are valued members. If an Official has a problem with a member, refer them to the Event Director. Under no circumstances shall an Official be rude, sarcastic, or impolite to any NASA member. Disputes with other Officials shall be settled quietly and in private. Any unresolved problems should be reported to the Event Director.

2.3 Executive Administration

2.3.1 Chief Executive Officer

The Chief Executive Officer has total executive authority, nationwide, over all regions, Officials, and all matters of any nature pertaining to NASA issues, except as otherwise stated in this subsection. The Chief Executive Officer's power to govern matters pertaining to any individual region or region shall only be limited by any applicable governmental laws, or by any terms set forth in any written contract made between the NASA National Office and the Regional Director of that region. The Chief Executive Officer will make judgments, definitions, determinations, clarifications, and settle all presented appeals. The decisions of the Chief Executive Officer are the final rulings and cannot be appealed. The Chief Executive Officer for NASA is Jeremy Croiset and can be reached through the National Office. Contact information is found here <https://drivenasa.com/staff-directory/>

2.3.2 National Chairman

Ryan Flaherty is the National Chairman and is responsible for the general health, welfare, and image of NASA on a national scale. He holds this position to oversee the national marketing program, sponsorship program, and ensure current projections are being met.

2.3.3 Chief Divisional Director

The Chief Divisional Director oversees all the NASA regions directly.

2.3.4 Regional Director

The Regional Director has total authority over all officials within his/her assigned region(s). He/she is responsible to oversee all aspects of the events conducted by his/her region(s). The Regional Director shall particularly oversee the appointment of Race Director(s) and School (HPDE) Director(s). He/she will also ensure that all events are run in accordance with all rules set forth in the CCR. Some allowances can be made, with authorization from the Executive Director.

2.4 Event Administration

2.4.1 Event Director

The Event Director has the power and authority over all local event Officials, except for the Regional Director (if present). The Event Director controls all aspects of the event and is the person responsible for the general conduct of the event in accordance with the CCR.

GENERAL RULES AND DEFINITIONS

2.4.2 Chief Instructor

The Chief Instructor should oversee all instructors, program implementation, curriculum fulfillment, licensing program, instructor training programs, and settle any conflicts that may arise between Instructors and students.

2.4.3 Registrars

The Registrars are responsible for implementing the proper registration procedures for each event, as set forth by the Regional Director.

2.4.4 Timing and Scoring

Timing and/or scoring methods are discretionary. The Race Director or Time Trial Director may choose any method (conventional or unconventional) of timing, scoring, and/or making grids. The method chosen may be implemented either in full or in part, or modified or discarded at any time, at the discretion of the Race Director or Time Trial Director.

2.4.5 Paddock Marshal

The Paddock Marshal should ensure that the paddock rules are enforced and issue polite verbal warnings to any violators. Any violators failing to comply with the paddock rules after being properly warned should be brought to the attention of the Event Director.

2.5 Pace Car / Safety Car- Driver

The Pace Car Driver is responsible for the operation of the Pace Car at the direction of Control. The pace car should display a blue flashing roof light. "Pace Car," and "Safety Car," may be used interchangeably.

2.6 Event Operations

2.6.1 Chief of Communications

The Chief of Communications (CC) is responsible for communicating with all Course Officials, including the Starter and the Re-Entry Marshal. The CC is responsible for relaying information regarding course situations, incidents, and major schedule deviations to the Operating Steward (OS). The Chief of Communications should ensure that a Course Officials' (Flaggers) meeting is held each morning.

2.6.2 Starter

The Starter is responsible for displaying the proper flags from the position assigned by the Chief of Communications. This position is usually located at (or near) start/finish, but not always (e.g. Mid Ohio Sports Car Course). The Starter will function under the direction of the Chief of Communications; however, the Starter may display an appropriate flag(s) for a local incident at his/her discretion.

2.6.3 Course Officials (Flaggers)

Course Officials are responsible for displaying the appropriate flags throughout the event to keep the drivers informed regarding conditions of the track and the approaching traffic. Additionally, they should effectively communicate all incidents and track conditions to Control. Course Officials should man the assigned flag stations at the direction of the Chief of Communications.

GENERAL RULES AND DEFINITIONS

2.6.4 Violation Controller

2.6.4.1 (Non-Competition Groups)

The Violation Controller should record all violations and should inform the Chief of Communications of all violations that may warrant a black flag to be issued. When a violator reports to the Black Flag Station, the Violation Controller will inform the Official manning the Black Flag Station of the violation, and the number of previous offenses recorded that day. The Official manning the Black Flag Station should politely issue the proper reprimand as follows:

First offense of the day: Warning.

Second offense of the day: Exclusion for the remainder of that session.

Third offense of the day: Exclusion for the remainder of that day.

NOTE: **All body contact incidents** shall be reported to the HPDE/TT Director immediately.

Offenses Defined (HPDE / TT/ Open Track / School Groups 1-3):

- Body Contact.
- Passing under any yellow or red flag.
- Passing in a no-passing zone.
- Unauthorized counter-course driving.
- Striking barriers or other track objects.
- Spinning.
- Four wheels off track.
- Repeated two wheels off track
- Over aggressive driving.
- Over aggressive passes.

Offenses Defined (HPDE / Open Track / School Group 4):

- Body Contact.
- Passing under any yellow or red flag.
- Unauthorized counter-course driving.
- Striking barriers or other track objects.
- Overly aggressive driving.
- Repeated spinning.

2.6.4.2 (Competition Groups)

The Violation Controller should record all violations and should inform the Race Director of all violations that may warrant penalties to be issued.

Offenses Defined (Competition Groups):

- Body Contact.
- Passing under any yellow or red flag.
- Unauthorized counter-course driving.
- Over aggressive driving.
- Illegal starts.
- Illegal blocking [Ref:(25.4.4)]

2.6.5 Chief Steward

The Chief Steward is responsible to ensure that the entire event is fully staffed with an adequate number of Officials for each needed position.

GENERAL RULES AND DEFINITIONS

2.6.6 Pre-Grid Marshal

The Pre-Grid Marshal is responsible for setting up the grid layout and space numbers, checking all cars for the proper event/group identification stickers, checking the drivers for proper attire. The Pre-Grid Marshal is required to obtain grid-order sheets and an entry list from registration or T&S. Generally, the Pre-Grid Marshal shall not direct the competitors to a particular space on the grid. He/she should ensure that all qualifying results are properly posted so as to aid the competitors in obtaining their proper grid space number. It is the competitor's responsibility to grid their vehicle in the proper space number.

2.6.7 Re-Entry Marshal

The Re-Entry Marshal should generally control the traffic entering onto the track at the direction of the Chief of Communications.

2.6.8 Operating Steward (OS)

The OS is responsible for the communication with the Emergency Response Coordinator (ERC), dispatching and coordinating Emergency Response Teams, and keeping the event running as close to the schedule as possible. The OS stations himself/herself next to the Chief of Communications, so as to be able to effectively communicate during the event.

He/she will obtain information either by listening to the course communication and/or from the Chief of Communications. During an emergency response effort, it is the duty of the OS and the ERC to establish a communication link between the incident scene and Event Control.

The OS reports to Race Director, and normally will make decisions as a race director, should the Race Director be unavailable. Whenever a Race Director is present (or available), the OS will consult the Race Director regarding operational decisions that may affect the schedule or the competitive aspect, such as ordering an early Checkered Flag, utilizing a pace car vs. Black Flag All during a qualifying session, etc.

2.6.9 Chief Scrutineer

The Chief Scrutineer supervises all Tech Inspectors and will make the ultimate decision as to which issues of legality will be reported to the Race Director. He/she should always notify the competitor in question before notifying the Race Director.

2.6.10 Tech Inspectors

Tech Inspectors work at the direction of the Chief Scrutineer.

2.6.11 Race Director

The Race Director is in control of all aspect of the competition and the competitors. The decision of the Race Director is final, unless it goes to Executive Appeal. [Ref:(17.5.4)]

2.7 Officials / Rules Hierarchy

This section is intended to clarify hierarchy among some officials and rules. Where there is a conflict, the following order should be used. Each item on this list supersedes the prior listed item whenever there is a conflict:

- Club Codes and Regulations
- Class Rules
- Local or Event Supplemental Rules
- Drivers' Meeting Information
- Orders From Officials
- Race Director

GENERAL RULES AND DEFINITIONS

- Regional Director (with respect to business matters, not competition or rules)
- Chief Executive Officer
- Medical Staff (with regards to patient care and their duties).

2.8 National Series Directors

National Series Directors are responsible for interfacing with each of the regions' local series administration for their respective series. They are also responsible for monitoring the overall health of the series. Some of the aspects of this position include:

- Serve as communication conduit between NASA National Office and regional series administration.
- Make recommendations to NASA National Office based upon analysis of collected data relevant to the series.
- Monitor related web forums and make comments as needed to keep the discussions relevant and constructive.
- Research and develop recommended rule changes.
- Attend the National Championships each year.
- Work with tech and race directors at the National Championships, making recommendations and providing information as needed.
- Track and report on national growth and trends.
- Identify current and potential future problems to provide for them to be addressed in a timely manner.
- Conduct annual regional series administrator meeting and travel to selected regional events outside of their home region.
- Maintain and update the series website.

HIGH PERFORMANCE DRIVING EVENT (HPDE) (SCHOOL / OPEN TRACK / TIME TRIAL / HYPERDRIVE)

HPDE Mission Statement (contribution by Barry Hartzel)

The purpose of the **NASA HPDE** program is to provide a structured and managed environment for participants to acquire the knowledge necessary for driving their cars at speed on a closed course.

Our mission is to enable **HPDE** participants to develop high levels of awareness, skill, and responsibility in the practice of high performance driving while having the time of their lives. In our experience an aware and skilled driver is a safer driver both on and off the track.

The following qualities embody the **HPDE** Program.

Awareness:

Being perceptive and knowledgeable of the situation at hand.

Responsibility:

Being able to respond swiftly and skillfully to the circumstances.

Teamwork:

Working together for the benefit, development, and safety of all.

Sportsmanship:

Exhibiting fair play, courtesy, and cooperation.

Discovery:

Being willing to learn and to be coached.

It is our intention to be true to our purpose, to accomplish our mission and to operate consistent with our values.

This is our stand.

This is what we will deliver.

HPDE PREFACE

Obviously, NASA cannot guarantee every person's safety when doing things of this nature. However, NASA has one of the best safety records in the business. Safety is no accident; and an outstanding safety record comes from having an outstanding team of Officials. The NASA Officials' prime objective is to help the participants enjoy their day safely. This means that they may have to send a few "bad apples" home early in order to protect the "adults" in the program. This has been NASA's basic philosophy since its inception as a fledging car club in 1989.

NASA offers these HPDE programs for a very good purpose. The Mission Statement on the previous page of this book tells it all. Those that have taken the time to read and embrace the Mission Statement will likely find themselves becoming a much better and safer driver. They will probably be more confident behind the wheel, with better car control skills, much more awareness, and the best thing is that they will have the time of their life, learning it the easy way. –Jerry Kunzman, NASA Co-founder.

3 HPDE RULES AND REGULATIONS

3.1 General Rules

All drivers are required to operate their vehicles within the rules, and within the limits of the marked course. Failure to do so compromises the integrity of the program and will not be tolerated. The NASA administration strives to promote qualities like good judgment, responsibility, and safe driving, both on the track and on the highways.

3.2 Definition and Terms

This section contains the rules that govern non-competition groups. The terms “School,” “Driving School” [Ref:(1.1.2)], “Open Track,” and “Hyperdrive” are used interchangeably in this publication, except where otherwise noted. Often times, all four terms are “generically” referred to as a “High Performance Driving Event” or (HPDE).

3.3 Program Overview and Intentions

Most NASA regions host a wide variety of HPDE type events each year, with some regions hosting events year-round. These events range in price and available space. Each region sets their own schedule, and their chosen format may vary slightly. However, it is the intent of all NASA regions to uniformly enforce the safety, eligibility, and personal conduct rules that are listed in all applicable publications (e.g. CCR, class rules, etc.). It should be noted that each region might have certain rules or restrictions that add to, or supersede, this publication.

3.4 Eligibility Requirements

- Be at least 18 years old (or 16 years old with parental consent*).
- Hold a current valid state driver’s license.**
- Have use of an automobile that meets NASA’s technical requirements.
- Hold a current membership with NASA, or a NASA sanctioned car club.
- Have proper safety equipment, as per the CCR and applicable group or series rules.
- Fully pay all applicable fees.
- Have no outstanding debts with NASA or NASA’s affiliates.
- Have knowledge of all applicable rules found in the *Club Codes and Regulations*, and fully agree to abide by them.
- Must be deemed physically fit by their physician to participate in a high stress and physically demanding sport such as auto racing.
- Sign all required waivers, and in particular the “gate waiver” before entering the facility.
- Have their car teched before going on track.

3.5 *Minors

A minor release form must be filled out and be on file with NASA at every event for 16 and 17 year old participants. All minor participants should have at least one parent or legal guardian present at all times. Some drivers under 16 years of age may be permitted per section 3.5.1.

3.5.1 **Addendum to Minors

Persons under 16 years of age may, under certain circumstances, be allowed to participate in on-track activities, including but not limited to: HPDE (open tracks, driving schools), racing events, hill climbs, autocross, etc. The following criteria and procedures must be met before a minor, under the age of 16 years, may be allowed to participate:

HIGH PERFORMANCE DRIVING AND TIME TRIAL

- 1) Submit a copy of the most recent report card. Applicants with negative comments and/or a grade(s) lower than a "C" may be denied or subject to extra scrutiny.
- 2) Submit a driving experience summary along with some results. This could be from various types of auto racing, racing schools, karting (not-indoor karting), etc. Season points standing usually suffice. "Driving the father's pickup truck on the farm," and other similar reasons are not acceptable.
- 3) Those applicants wishing to apply for a competition license, provisional license, or a license evaluation must submit a completed medical.
- 4) All documents must be submitted together, which includes any optional documents such as letters of recommendations. All documents submitted together shall be sent to the local Regional Director where the applicant wishes to do their first event. The Regional Director must approve of the applicant's desired starting group (e.g. HPDE 1, 2, 3, 4; TT; license evaluation, or racing).
- 5) The Regional Director's decision is not subject to the appeals rules found in this publication.
- 6) The Regional Director will then forward all documentation in one email to the National Office for evaluation.
- 7) The Chief Executive Officer (or his appointed proxy) will evaluate applicants on a case-by-case basis.
- 8) The Chief Executive Officer (or his appointed proxy) should speak with the parent that will be attending all events,
- 9) The Chief Executive Officer will notify the Regional Director via email of his decision.
- 10) All accepted applicants must execute a minor waiver, which includes a parent or legal guardian's signatures, before any on-track driving, at each event. The minor waivers are typically located at Registration and/or "Driver Info."
- 11) A parent or legal guardian must accompany accepted applicants to each event.
- 12) It is strongly advised that the parent or legal guardian accompanying the minor be present during all conversations with officials but must not interject or interfere with those official conversations.
- 11) Failure to follow these steps and/or not submit documents in one package or email will be rejected but may be resubmitted following the proper order and procedures outlined in this section.

3.6 Non-Eligibility / Non-Registered Drivers

Only registered drivers and officials are allowed to operate a vehicle on the track. Anyone not officially registered in the event, that is found operating a vehicle on the track at any time, will be immediately ejected from that event, and from NASA, along with that person's guests and crewmembers. Additionally, all NASA sanctioned clubs, affiliates, and other sanctioning bodies will be notified.

4 HPDE Participant Conduct

4.1 Participant Conduct - Expectations

Every participant [Ref: (1.4.4)] at a NASA sanctioned event shall conduct themselves according to the highest standards of behavior and sportsmanship* particularly in their relationship with other drivers and Officials, and in a manner that shall not be detrimental to the reputation of NASA. Failure to do may result in harsh penalties.

* The term "sportsmanship," as used here, is meant to convey an expectation of conduct, and in no way implies that participants are involved in a sporting event or contest.

4.2 Conduct of Guests and Crew

Drivers shall, at all times, be responsible for the conduct and behavior of those accompanying them to an event such as crew, mechanics, and friends. Any offense committed by the driver's crew, mechanics, or friends will be directly chargeable to the driver.

4.3 Property Damage

Damage to the racetrack, its surface, fencing, paddock, walls, buildings, trailers, equipment, vehicles, etc., by the driver (including his/her friends, crew, and sponsors) is the responsibility of the driver, and said driver agrees herein to make restitution. This agreement is binding when a driver enters the event.

4.4 Disabled / Handicapped

NASA has built itself, and prides itself, on being very accommodating to as many people as possible. Since different NASA regions host various activities at a wide variety of locations, it is impossible to maintain a consistent level of proper accommodations for the disabled. Most tracks have some accommodations for the disabled; however, NASA recognizes the need for improvements at a number of facilities. NASA will make whatever arrangements and adjustments within its powers at each event in order to better accommodate any disabled person. However, NASA cannot always anticipate what specific temporary changes would be most helpful at any given facility. Therefore, any disabled person that is planning to attend a particular event is encouraged to contact the local NASA office; and the staff will be happy to see to it that the best practical arrangements are made.

4.5 HPDE Passenger Privileges

A passenger is defined as any participant possessing the proper wristband or credential, riding in a moving vehicle while on track, yet is not in physical control of that vehicle. NASA Instructors are not considered passengers for the purposes of this section. All passengers must be at least 18 years old. Minors that are participants in the event should not be a passenger, unless riding with an instructor, for the purposes of instruction.

1. The ability to take a passenger on-track is a revocable privilege, not a right.
2. Passengers may be allowed in all HPDE groups, unless otherwise specified.
3. Group 1 ("School" or Beginner) participants must get specific permission from their Instructor before a passenger may be allowed in the vehicle.
4. Passengers must use the minimum safety equipment and attire as required of the driver.
5. Passengers should not be allowed in vehicles where they are sitting near or below obstructions (e.g.. "Petty bar") that may pin or trap them or cause other possible harm.
6. Anyone that is involved in a spin or off-track excursion with a passenger in the car may lose his or her passenger privileges for the day.
7. Only one (1) passenger is allowed at any given time, in any car, unless an Instructor is driving.

HIGH PERFORMANCE DRIVING AND TIME TRIAL

8. Passengers should not commit any action as to cause interference or distraction of the driver or any other drivers.
9. Passengers should keep their arms and hands inside the vehicle at all times.
10. Passengers are not permitted to place any part of their bodies, such as their hands, in any area that is between any roll bar/cage tubing and the body panels of the interior. Doing so may result in crushed limbs. Enforcement of this rule is the responsibility of the driver.
11. Passengers are not allowed in open-top cars that do not provide rollover protection for the passenger side of the car (e.g. an original Shelby Cobra.)

4.6 Responsibilities for Valuables

Theft is virtually unheard of at NASA events however the management encourages all participants to lock up their valuables. Participants are strictly responsible for the safe keeping of their own belongings. The event facility management, NASA, and NASA affiliates take no responsibility for any loss, damage, or theft of any item while at the event.

4.7 Alcoholic Beverages

Consumption of alcohol by any participant [Ref:(1.4.4)] is expressly prohibited.

4.8 Narcotics and Dangerous Drugs

The use of any dangerous drugs or narcotics, as defined by Federal and/or state laws, by any participant is specifically prohibited, unless prescribed by a doctor. Any driver, crewmember, mechanic, or Official found under the influence of marijuana, prescription or not, will be ejected and subject suspension.

4.9 Rain and Inclement Weather

The event will not be canceled due to inclement weather unless ordered by the Event Director. It is the responsibility of the driver to bring appropriate equipment such as rain tires, clothing, etc.

5 HPDE Rules of the Pit lane and Paddock

5.1 Paddock Rules

- **Children must remain under CLOSE adult supervision at all times. Harsh consequences can result such as severe injury or death! Parents shall not allow their children to play around any pets that may be at the facility unless that pet belongs to that parent.**
- The speed limit in the paddock is five (5) MPH for any vehicle other than emergency vehicles. This speed limit applies to all motorized and non-motorized vehicles.
- Oil, water, electrical power, and compressed air are the responsibility of the entrant.
- Fuel may not be available at the track unless otherwise announced in the acceptance letter, emailed event confirmation, and/or at the drivers' meeting.
- Entrants are urged to refuel on concrete areas if available.
- NASA reserves the right to allow fueling only in designated areas.
- Participants must keep water on hand in the paddock in case of fuel spillage. A gasoline spill can quickly destroy the asphalt surface. If not washed away with water, the bill to fix the damage can quickly add up to \$1,000 or more for which they will be liable.
- Entrant-provided boards must be placed under loaded jack stands to avoid damage to the asphalt surface.
- Any leftover trash, vehicle body parts, tires, etc. must be taken out of the facility.
- Proper parking is a must to ensure that all participants will fit into the paddock.
- Parking in fire lanes is prohibited.

5.2 Pets at the track

Some tracks prohibit pets and/or have special rules regarding pets. It is recommended that all pets be left at home. However, should a pet be brought to a track that allows pets, the following conditions apply: The owner is solely responsible for the actions of his/her pets. This means cleaning up after them and being held legally liable if their pets bite another pet or a human. Additionally, all pets must be kept on a leash, in a cage, or in a vehicle at all times. No pets are allowed in the pit lane at any time.

5.3 Loud Engines

Each facility has its own set of rules for allowed sound levels at all times of the day or night. It is the responsibility of the participant to check with the local NASA Office.

5.4 Gas Cylinders

All compressed air bottles/gas cylinders with a pressure of over two hundred pounds per square inch (200 PSI) must be securely fastened vertically so as not to topple over or shall be fully enclosed in a structure, such as a rollaway or crash cart. Anytime a cylinder is not secured upright or enclosed in a cart there must be a protective cage or cap around the head.

5.5 Bicycles, Skates, Moped, etc.- (PARENTS!):

No one without a valid state driver's license may operate any mode of transportation in the paddock. Skates, skateboards, motorized skateboards, and in-line skates are not permitted at any time.

HIGH PERFORMANCE DRIVING AND TIME TRIAL

5.5.1 Segway™

Use of the following models of Segway products is permitted: i67, e67, p133, i80, XT, i2, and x2. Additionally, use of all of the following: Ninebot S, S-PRO, and S-plus; all must be used with optional handlebars, including aftermarket.

5.6 Minimum Attire

All participants must wear at least a T-shirt, shorts, long pants, and closed-toe shoes. Shorts in the pit lane are permitted except during sessions requiring refueling such as endurance racing. Some racetracks may have more restrictive requirements.

5.6.1 Usage of Aerial Photography

Aerial photography, as defined by Section 1.2.8 [Ref:(1.2.8)] is strictly prohibited without prior written consent from the National Office.

6 HPDE Course Conduct

6.1 Purpose and Philosophy

The following rules apply to course conduct, as well as common courtesy and good judgment. Participants are held responsible for their conduct just as much on the track as when they are in the paddock. Any over-aggressive driving, risky pass attempts, or discourteous driving will result in substantial penalties.

6.2 Preparation for Course driving

1. Both front side windows must be completely open.
2. All occupants must keep hands and arms inside car at all times, except for hand signals.
3. Check all safety equipment, including helmet straps and belts.

6.3 Passing Rules

1. Passing in "No Passing Areas," as defined by the Passing Rules (available at the drivers' meeting or Registration) is prohibited. [Ref:(25.4.1)]
2. Passing under any yellow flag situation until the driver is past the incident, or past the next manned flag station that does not display a yellow flag is prohibited. [Ref:(7.2 - 7.4)].
3. If an Instructor driving a car waves a car by, that does not count as a pass. (Instructors will have an "X" on their cars.) Drivers may not pass under yellow, even if they perceive a "wave by" from another participant.
4. If a car is having mechanical trouble and is pulling off the track, a pass is allowed regardless of the passing rules.
5. A driver may not pass another driver in a no passing zone or situation, even if the other driver waves him/her by.
6. The driver attempting to make a pass is solely responsible for safe outcome of that pass. Drivers making a pass should be certain that the driver ahead of them can see them before attempting to pass.

6.4 Rule Violations

Any rule violations, including spins and off-track excursions, may result in harsh penalties. The first violation will result in a warning. The second violation will result in exclusion from the rest of that session. The third violation will result in exclusion from the rest of the day. [Ref:(2.6.4.1)]

6.5 Stopping On Course

Stopping on course is expressly prohibited unless it is an emergency. "Stopping" includes abrupt and/or unexpected slowing to a near stop. Stopping to help a disabled car is prohibited. An emergency, for the purposes of this section, is defined as only those events concerning medical problems, mechanical failure, on-board fire, or damage from an incident that renders the vehicle unfit to continue.

6.5.1 Stopping in an Emergency

Anytime a driver is forced to stop in an emergency; the first concern should be to place the car in an area where it will not cause danger to the other drivers. When stopping off course, the driver should be careful not to park on dry grass areas where fire can be a hazard.

HIGH PERFORMANCE DRIVING AND TIME TRIAL

6.6 Counter-Course Driving

Driving a vehicle on the course in the direction opposite to the normal traffic flow is strictly prohibited with the following exceptions:

- When the track is closed, or cleared, as deemed by the Chief of Communications.
- When ordered to do so by the Event Director, or an Emergency Response Team Official.
- Whenever a driver must do so for a short distance, in an extreme emergency and only for the sole purposes of getting out of harm's way.
- When ordered to do so by a Course Official.

6.7 Spins or Off-Track Excursions

If the driver is involved in a spin or off-track excursion, he/she shall pull into the hot pits immediately. The Officials will need to check the car and talk to the driver. If the driver spins off the track, he/she shall try to enlist the help of a Course Official to wave him/her back on safely.

6.8 Body Contact

Body contact cannot and will not be tolerated. Anyone involved in body contact must report immediately to the head of pit lane. Harsh penalties will be imposed, including but not limited to, permanent ejection from NASA.

6.9 Post Accident Emergency Procedures

All persons involved in a major crash or roll-over, shall remain in the vehicle (unless it is on fire) with their seatbelts and helmets on, until the Emergency Response Team arrives.

6.10 Post Accident Reporting

All persons involved in any "**significant accidents**" are **required** to report to the medical staff immediately. Failure to do so **will** result in **suspension** and may void personal medical insurance. "**Significant accidents**" **are defined as:**

1. All vehicle roll-overs, regardless of damage.
2. Any impact rendering the vehicle inoperable.

7 INSTRUCTIONS FOR HPDE, SCHOOL, AND OPEN TRACK FLAGS

Flags are the MOST IMPORTANT form of communication the Officials have with the drivers while they are on the track. Therefore, it is imperative that drivers know what each flag means.

Note: Flags listed in this section are simplified from the Competition Flags, for the purposes of HPDE Program. Competition License Candidates are held responsible for the information contained in the “FLAGS, SIGNALS, AND COMMUNICATION” section #19 of the CCR.

7.1 Green Flag



Session is open.

7.2 Yellow Flag - Motionless



Slow down. Danger ahead. **PASSING** is prohibited, until completely past the incident, or until past next manned flag station that is not displaying any Yellow Flag(s), whichever comes first. There may be one (1) yellow flag covering more than one incident. There may be several yellow flags before reaching the emergency area. [Ref:(25.4.1)]

7.3 Yellow Flag - Waving

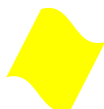

Great danger, slow down. Be prepared to stop. Passing is prohibited until completely past the incident, or until past the next manned flag station that is not displaying any Yellow Flag(s), whichever comes first. Note: There may be one (1) yellow flag covering more than one incident. [Ref:(25.4.1)]

7.4 Double Yellow Flags



Full course yellow condition exists. Be prepared to encounter a Pace Car and/or emergency vehicles. Drivers should not significantly slow down. Be prepared to encounter a slow-moving pack and other local flag conditions. Drivers shall obey the local flag conditions (e.g. waving yellow). Passing is prohibited until the Pace Car (if on track) has pulled off and the driver has passed the next manned flag station that is not displaying any Yellow Flag(s). [Ref:(25.4.1)]

7.5 Black Flag - Open



Track Officials want to talk to you. Complete current lap and pull into the pits for consultation.

7.6 Black Flag - Furled



Warning. You are driving in an unsafe manner or you did something wrong. If you continue to do so, an open black flag will be shown to you.

7.7 Black Flag All - Waving



All manned flag stations will display waving black flags during this condition. Some flag stations might display a sign with the word “ALL.” All cars proceed slowly to the hot pits. Passing is prohibited.

HIGH PERFORMANCE DRIVING AND TIME TRIAL

7.8 Checkered Flag



Session is over. Complete current lap cautiously and exit via pit lane or otherwise designated end-of-session track exit point. Passing rules remain the same during the checkered flag lap as during the session.

7.9 Red Flag



Emergency. Come to an immediate and controlled stop on the side of the track in a safe location.

7.10 Blue Flag



(with diagonal yellow stripe)

Another vehicle is approaching quickly or following very closely and may attempt a pass. The driver receiving the Blue Flag should consider giving a passing signal.

7.11 Debris Flag



(yellow and red stripes)

Caution. To be displayed motionless. Oil or debris may be present on the track surface or a slippery condition may be present. This flag will be taken down after several laps, but that does not mean that the condition has been resolved; just that the driver should now be taking it into account

7.12 White Flag



Emergency vehicle or slow-moving vehicle is on course.

7.13 Emergency Vehicle Flag



(white flag with a red cross)

There is an emergency vehicle on course. Pass with extreme caution.

7.14 Mechanical Black Flag



(with orange ball in center)

(a.k.a. *meatball flag*) There appears to be something mechanically wrong with your car. Proceed to the pits at reduced speed.

7.15 Pace Car (with lights on)



Follow the Pace Car at about the same speed. Do not pass the Pace Car unless instructed to do so by the Pace Car personnel. Passing is only allowed after the Pace Car has pulled off and the driver has passed the next manned flag station that is not displaying a yellow flag.

8 INSTRUCTIONS FOR HPDE HAND SIGNALS

8.1 Slowing down

Whenever a driver is entering the pits or is no longer driving at normal traffic speed, he/she must extend an arm in a vertical position with his/her fingertips towards the sky, if possible.

8.2 Passing signals

To assist another driver in overtaking you, hand signals should be used whenever possible. The driver may do this by pointing to the side he/she wants to be passed on, in such a fashion that is visible to the overtaking driver.

8.3 Flag Station Acknowledgement

All drivers shall give a wave of acknowledgement to every manned turn station during the cool down lap.

9 NASA Instructor License

9.1 NASA Provisional Instructor License

A NASA Provisional Instructor License may be issued to anyone meeting with the approval of the HPDE/ School Director [Ref:(2.4.1)]or Chief Instructor.

9.2 NASA Instructor License Eligibility Guidelines

An Instructor License may be issued, with the approval of the HPDE Director or the Chief Instructor.

9.3 NASA Instructor License Renewal

A NASA Instructor License should not expire as long as the holder instructs at a minimum of 4 events per year. Once an Instructor License has expired, a new license must be approved.

9.4 Competition Licensing Instructors

Certain Instructors should be selected by the HPDE Director or the Chief Instructor to function as Competition Licensing Instructors.

10 NASA INSTRUCTOR PROGRAM

10.1 Purpose

The purpose of this section is to outline the most important responsibilities of a NASA Instructor. The HPDE (school) program is very important, and the NASA Directors strive to keep it one of the most well-run programs in the United States. Teaching the basics to a beginner is the most important job in NASA. The Instructor is the first one to make an impression on the beginner. They have the power make the beginner's first experience safe and enjoyable. But if improperly handled, the beginner may not find the safety and enjoyment that will bring him/her back another time. The NASA Instructor has a purpose - to ensure that the beginners enjoy their day and do it safely. No one can be forced to learn. The NASA Instructor's duty is to allow the beginner to have fun, and it's their obligation to help ensure their own safety as well as the safety of their student. The following outline describes what is expected of a NASA instructor.

10.2 DUTIES OF NASA INSTRUCTOR

10.2.1 Supervision of students

All Instructors are responsible for proper supervision of their students. They are required to know the whereabouts of their students at all times.

10.2.2 Schedule

The Instructor must be on time. The Instructor must report to the Chief Instructor or any event Official when requested to, whether scheduled or not.

10.2.3 Student Curriculum

The Instructors are required to follow the prescribed curriculum. They shall also fill out appropriate grading or student progress-tracking such as an HPDE Passport.

10.2.4 Questionnaire

Instructors are required to ensure that the students have filled out and submitted the questionnaire, if one is being used.

10.2.5 Classroom/clipboard session

There should be a classroom session or a clipboard session between the Instructor and his/her students immediately following each on track session. The Instructor should quiz each student on knowledge of the CCR at least once during each session. A "download session" for all the participants of each group, immediately following their session is strongly recommended.

10.3 REGULATIONS FOR NASA INSTRUCTORS

10.3.1 Rules Knowledge

The Instructors are required to know the CCR. The Chief Instructor should test each instructor's knowledge of the rules from time to time.

10.3.2 Instructor IDs

The Instructor must wear and display his/her NASA instructor license at all times while at track.

HIGH PERFORMANCE DRIVING AND TIME TRIAL

10.3.3 Instructor's Vehicles

The NASA Instructor is not required to bring a vehicle to the track. However, if the Instructor does bring a vehicle and wishes to drive it on track, it should be track worthy and the vehicle must have a large "X" on each side and one (1) large "X" on the rear of vehicle. Each instructor is responsible for the mechanical condition of their vehicle, therefore are not required to report to Tech.

10.3.4 Vehicle Operation

All Instructors are expected to drive their cars in a safe and controlled manner.

11 **HPDE TECHNICAL REQUIREMENTS**

11.1 **Purpose**

For the purposes of maximizing participant safety, every car should pass a technical inspection. A full and complete technical inspection should be performed on each car for each event.

11.2 **Preparation Instructions**

- Examine the Technical Inspection Form and make sure that the car meets or exceeds the minimum requirements.
- Review the registration page for the desired event for specific information. A list of authorized inspection stations is available from the local office and are usually published on the Region's Website.
- Do not show up at the "appointment only" shops without an appointment. They are very busy and may not be able to accommodate you.
- If you choose to tech your car at the track, you must:
 - A - Pay the appropriate late tech fee, if any, and
 - B - Have your car ready for tech at the appropriate time.
- NASA, SCCA, and ALMS competition vehicles with a current logbook may be exempt from tech inspection. The vehicle's logbook must be presented to a Tech Inspector at the track. The Inspector will mark the exemption on the Technical Inspection Sheet and sign it
- It is highly recommended that a good fire extinguisher be kept in all cars; securely mounted with a metal bracket within easy driver's reach. A-pillar mounts are prohibited.
- Once teched (or pre-teched) simply place the form on your dash or windshield for the first session on grid. A grid marshal will collect it and place a sticker on your car.

11.3 **Required Safety Equipment - Driver**

Disclaimer: Conformance to these regulations is the driver's responsibility. These regulations do not guarantee or imply that injuries or death will not occur. If there are any questions or problems with these regulations it is the reader's responsibility to contact the NASA office, or a NASA official immediately.

All participants shall utilize equipment that meets or exceeds these minimum requirements, while driving on track (Note- passenger equipment must meet or exceed these minimum requirements; but do not necessarily have to match the driver's equipment):

1. Use a proper fitting helmet that meets Snell 2005 (SA2005; M2005) or ECE 22.05, or newer (or equivalent) standards for cars or motorcycles.
2. The driver and any passenger must utilize modern style stock seatbelts in very good condition, or a DOT approved restraint system, while operating a vehicle on the track. Lap belts used without any shoulder restraints are not permitted. Restraint system requirements are listed in Section #11.4.8. The only four-point belt systems that are allowed for use in HPDE / TT are 1) those that carry an "FIA B-xxx.T/98 (or newer) certification, or 2) those that carry a label from the belt manufacturer stating that the belts meet Federal Motor Vehicle Safety Standard (FMVSS) 209 and that the belts were designated for the specific vehicle (e.g. "For use only in BMW E36 models"). Such label must be easily visible to the NASA inspector. Note- four-point belt sets that have a DOT-only certification are prohibited.
3. Non-synthetic fabric clothing (i.e. cotton).
4. Open-toed shoes and tank tops are prohibited while on track.
5. Drivers should wear eye protection such as goggles, safety glasses or face shields preferably made of new impact resistant materials.

HIGH PERFORMANCE DRIVING AND TIME TRIAL

6. It is recommended that any corrective eyeglass material used be made of safety glass type that meets U.S. Government standards.

11.4 Vehicle Technical Regulations

Every vehicle entered in any NASA sanctioned HPDE event should meet or exceed these requirements. For any vehicle with safety equipment that has been added, modified, or removed, the technical standards found in Section 15 of the CCR will apply. Outdated racing belts may be allowed per Section 11.4.8 of the CCR.

11.4.1 Appearance

All entered vehicles must be in good condition and appearance. Vehicles with excessive body damage, primed body panels, etc., are prohibited. The vehicle must meet the "50/50" rule, which means they must look undamaged and straight at fifty (50) mph from fifty (50) feet.

11.4.2 Wheels and Tires

The general condition of the tire and rim assembly must be good. There should be no cracks or other damage to the wheel. There should not be cords exposed, bubbles, or other visible damage on the tire. All lug nuts must be present and tightly hold the tire and rim assembly to the car's hub.

11.4.3 Steering and Suspension

The steering mechanism and the suspension of the car should be checked for its general condition. The front and rear wheel bearings should be tight and play-free. There should be very little or no play in the suspension of the car and in the steering mechanism.

11.4.4 Engine Bay

There should be no significant fluid leaks from the engine, radiator, or hoses. A radiator overflow of at least one-liter capacity should be used. Oil breathers or vents shall return the oil to the engine or should terminate in a catch tank of at least (1)one liter. All hoses carrying fluids should be in good condition with no cracks or other damage.

11.4.5 Brakes

The brakes should be in good working condition and must be able to stop the vehicle in a reasonable distance in a safe and controlled manner. The pedal pressure should be adequate. The fluid level must be above the minimum limit as specified by the manufacturer. The brake lines must be in good condition.

11.4.6 Disabled Drivers - Controls

All vehicles with special controls are the responsibility of the driver. NASA will not assume any liability for poor design and /or failure of any such mechanism. As such, NASA cannot provide approval or disapproval for the design or method of operation. However, vehicles driven in an unsafe manner may be removed from the track regardless of the cause.

11.4.7 Roll Bars

All open cars should have a roll bar installed to help protect the occupant(s) from injury during a roll-over. The main hoop shall be one continuous piece with smooth Mandrel bends with no evidence of crimping or wall failure. All welds should be of the highest possible quality, with full penetration [Ref:(15.6.18)]. All cars with roll bars are required to have adequate roll bar padding per CCR section #15.6.4. In cases where the driver's head may come in contact with the roll bar should the seatback fail, a seatback brace is required in conformance with section #15.6.24. Acceptable roll bars include, but are not limited to, the following:

HIGH PERFORMANCE DRIVING AND TIME TRIAL

Hard Dog

All Hard Dog brand roll bars that shows, "Meets NASA requirements..." on their website.

Auto Power

Street Roll Bar
Street-Sport Roll Bar
Race Roll Bar

Blackbird Fabworx (Miata / MX5 / 2017 Fiat 124)

SD (for NA and NB)
RZ (for NC and ND)
GT3 (for NA, NB, NC and ND)

The above roll bars are examples only. NASA does not endorse any brand or model and will not be held liable for any failures of roll bars.

11.4.8 Seatbelts and Harnesses

The seatbelts should be in good condition. No damage may be present on the seatbelts and they must be the factory configuration. Any harness or any restraint system, other than factory stock, shall conform to CCR section #15.5, in all respects except for the expiration regulations. Harnesses that are expired for racing may be used providing that they are in at least very good condition. Passenger seatbelts must meet the same minimum requirements per the CCR as the driver seatbelts if being used by a passenger. Note-passenger equipment need not match the installed equipment on the driver's side. See Section 11.3 for more about four point harnesses. Stock / OEM belts should not be worn with hard shell, fixed back racing seats. Those seats should have a racing harness.

11.4.9 Battery

The battery should be securely fastened to the car. No Bungee cords or rubber cords may be used to function as the sole hold down mechanism. An electrically non-conductive material should cover the positive battery terminal. Any battery located inside the driver's compartment should be fully covered and firmly secured to the chassis (or tub) in a marine type battery case. Dry cell, gel cell, and AGM batteries may be mounted without a surrounding case however a case is still recommended. Lithium ion batteries must be outside of the passenger area of the vehicle. Note- a ruptured lithium ion battery is subject to instant ignition at such high temperatures, the owner/ builder runs the risk of the entire vehicle being consumed by the fire.

11.4.10 Fuel Caps

All vehicles should utilize fuel caps such that the fuel will not spill out of the fuel tank under hard driving. Operational Monza type caps are prohibited. (Decorative Monza style covers for regular fuel caps are permitted).

11.4.11 Exposed Wires

There should be no exposed wires inside the driver's compartment such as to interfere with the safe operation of the vehicle. No live (hot) wires may be exposed anywhere in the vehicle.

11.4.12 Seats

All seats must be securely fastened to the structure of the car such that they are strong enough to withstand a major impact. If replaced, the replacement seat should be installed according to the manufacturer's instructions. Expired FIA seats may be used in HPDE without a seat back brace if one was not required originally. Passenger seats must meet the same minimum requirements, per the CCR, as the driver seat, if used by passengers. Note-The passenger seat does not have to match the driver's seat.

HIGH PERFORMANCE DRIVING AND TIME TRIAL

11.4.13 Loose Objects

All loose objects in the vehicle's passenger compartment should be removed.

11.4.14 Car Numbers

The vehicle should exhibit its assigned car number (if any) on both sides of the car.

11.4.15 Rearview Mirrors

The vehicle should have at least one rear view mirror affixed such as to provide the driver with good visibility to the rear.

11.4.16 Camera Mounts

Video camera mounts are unrestricted.

11.4.17 Hoses Inside Cockpit

All hoses carrying any hot or flammable liquids should be metal or reinforced.

11.4.18 Lights

There should be at least two (2) working red brake lights visible from 300 feet to the rear (except formula cars, sports racers, and other vehicles specifically approved by the Event Director). Certain other race cars may be exempt at the discretion of the Event Director.

11.4.19 Tow Eyes

It is STRONGLY recommended that all vehicles have at least two (2) easily accessible (and usable) tow eyes; one (1) in front and one (1) in back.

The tow crew should attempt to avoid damaging the participant's vehicle. However, should damage occur in the course of loading, towing, preparing to tow, or unloading NASA and / or the tow crew will not be held responsible for any damages.

11.4.20 Mufflers: Sound Limit

There may be a specified noise limit for each event. For the purposes of this section the term "Black Flag" refers to either a standard Black Flag, or a Mechanical Black Flag. A vehicle measured to be over the sound limit will be Black Flagged. The Black Flagged driver must pit immediately. Failure to pit immediately when given the Black Flag for a sound violation will carry extremely severe penalties, typically a fine of \$500. The vehicle will not be allowed back on the racetrack until significant changes are made to make the vehicle quieter. **The following rules apply to all events unless otherwise specified:** *[A car Black Flagged for excessive noise two (2) times during the same event may be excluded from the event. No car shall be re-included unless specifically permitted by the Event Director. A bonafide mechanical failure of the muffler/exhaust system will not be held against the driver; however, it must be satisfactorily fixed before further on track participation is allowed.]*

Drivers should note that different venues may measure sound differently and things such as surrounding buildings, walls, measuring distance, etc., may give a higher or lower reading than expected. All drivers are responsible for meeting the sound limit requirements of the venue.

HIGH PERFORMANCE DRIVING AND TIME TRIAL

11.4.21 Alcohol Injection

Tanks containing alcohol (e.g. methanol) that exceed 50% alcohol by volume should carry an FIA FT3 (or higher) rating and be installed per fuel cell regulations found in CCR Section [Ref:([15.4](#))]. Tanks containing 50% or less alcohol by volume may use any container per the manufacturer's instructions or recommendations. Under all circumstances tanks or containers must be mounted in an area that is completely separated from the driver by a bulkhead or firewall.

11.4.22 Exhaust Exit

The exhaust must exit behind and away from the driver compartment.

11.4.23 Electric and Hybrid Powered Vehicles

HPDE and TT production vehicles powered, all or in part, by an electric motor, must display a red circular dot on the lower left side of the windshield, in a visible location to warn safety crews of possible high voltage and alternative batteries. The dot shall be approximately one inch in diameter and can be obtained at any commercial store, homemade, and found at Registration. Non-production vehicles (e.g. stock car, radical, spec racer, etc.) that are powered, all or in part, by an electric motor must follow the decal rule for electric powered race vehicles found in section 15 of the CCR.

COMPETITION SECTION

Racing is a balance of passion and emotion, while playing chess and ballroom dancing.
Albert Butterfield, circa ~ 2006

12 COMPETITION ENTRY REGULATIONS

12.1 Official Notice of Disclaimer

NASA makes an effort to provide participants with a safe environment for everyone involved. Despite strict rule enforcement, and strict rule adherence, all participants must be aware that their mere presence at an event presents a chance of becoming critically or fatally injured, even by no fault of their own. These rules do not guarantee, or imply, that injuries or death will not occur. If there are any questions or problems with these rules and regulations, it is the participant's responsibility to immediately contact the National Auto Sport Association (NASA) office before entering an event facility.

Additionally, all NASA racing class rules apply ONLY to NASA sanctioned events. If a participant participates with another organization, club, or sanctioning body using a set of NASA owned or published rules, whether all or in part, that participant must be aware that NASA will take no responsibility for any actionable incidents arising from the use of said rules, under any circumstances.

12.2 Participant Eligibility and Requirements

Any driver wishing to enter a NASA sanctioned event, must meet the following requirements:

1. Be at least 18 years old (or 16 years old with parental consent*).
2. Hold a currently valid state driver's license.**
3. Have use of an automobile that meets NASA's technical requirements.
4. Hold a current membership with NASA, or a NASA sanctioned car club.
5. Have proper safety equipment, as per the CCR, series rules, and / group rules.
6. Fully pay all applicable fees.
7. Have no outstanding debts with NASA or NASA's affiliates.
8. Have knowledge of all of rules found in the *Club Codes and Regulations*, and fully agree to abide by them.
9. Must be deemed physically fit by their physician to participate in a high stress and physically demanding sport such as auto racing.
10. Sign all required waivers, and in particular the "gate waiver" before entering the facility.
11. Have a current annual tech sticker on their car.
12. Hold a valid NASA competition license or meet section #14.2.

12.3 *Minors

A minor release form must be filled out and be on file with NASA at every event for 16 and 17 year old participants. All minor participants should have at least one parent or legal guardian present at all times. Some drivers under 16 years of age may be permitted per section 3.5.1.

12.3.1 **Addendum to Minors

Persons under 16 years of age may, under certain circumstances, be allowed to participate in on-track activities, including but not limited to: HPDE (open tracks, driving schools), racing events, hill climbs, autocross, etc. The following criteria must be met before a minor, under the age of 16 years, may be allowed to participate:

- Parental consent must be made and a completed and signed minor waiver form submitted to the event registration staff at each event.
- The Regional Director must approve and should have specific permission from the Executive Director.
- The minor should have some prior experience to justify the on-track activity as being reasonably safe and prudent.

RACING

- The performance of the vehicle driven by the minor should be reasonable and safe given the minor's prior track experience.
- All NASA safety rules and precautions must be followed.
- It is required that at least one parent or legal guardian be present at the event.
- It is strongly recommended that the parent or legal guardian accompany the minor during any instructional periods and any discussion with stewards. However, the parent(s) are not to interfere with the discussion.

12.4 Non-Eligibility / Non-Registered Drivers

Only officials and registered drivers are allowed to operate a vehicle on the track. Anyone not officially registered in the event, that is found operating a vehicle on the track at any time, will be immediately ejected from that event, and from NASA, along with that person's guests and crewmembers. Additionally, all NASA sanctioned clubs, affiliates, and other sanctioning bodies will be notified.

RACING

13 NASA PROVISIONAL LICENSE

13.1 Issuance of a NASA Provisional License

NASA Provisional Licenses are issued from the NASA Regional Office and are only honored at events hosted by the Region of issuance. To be considered for a Provisional License, the driver must complete one of the following conditions:

13.1.1 NASA licensing program:

1. Pass the Region's licensing school or evaluation.
2. Pass a written test and a technical compliance demonstration.
3. Approval of the Licensing Instructor.
4. Driver's attire must meet the NASA minimum standards for racing [Ref:(15.17)]
5. Submit a copy of their driver's license.
6. Submit a copy of their Physical Examination form.
7. Submit the appropriate fee.

13.1.2 SCCA Regional Licensing program:

1. Submit a copy of their Novice Permit with school requirements completed.
2. Submit a copy of their driver's license.
3. Submit a copy of their Physical Examination Form.
4. Submit the appropriate fee.

13.1.3 NASA or SCCA Vintage Licensing program:

1. Submit proof of completion.
2. Submit a copy of their driver's license.
3. Submit a copy of their Physical Examination Form.
4. Submit the appropriate fee.

13.1.4 NASA or SCCA accredited racing school:

1. Submit a copy of their Certificate of Completion.
2. Submit a copy of their driver's license.
3. Submit a copy of their Physical Examination Form.
4. Submit the appropriate fee.

13.1.5 Provisional Licenses Completion:

Each time a Provisional License holder completes a race without incident, he/she must obtain a proprietary punch through their provisional license card by the Race Director, or his/her appointee. The provisional license card must be filled out and turned in to the Race Director at the beginning of an event and collected back at the end of the event. Once four clean races have been punched, the Provisional License is complete, and may be submitted to their Region along with the other requirements as listed in the section "Issuance of NASA Competition License" to obtain a Competition License.

RACING

13.2 Rookie Status

Any NASA Provisional License holder is defined as a "Rookie," and will remain so until they have finished eight (8) races without significant incident. Additionally, the Race Director may place any driver on Rookie status. Rookie status is simply a designation and implies no punitive reflections or consequences. A Provisional License holder that fulfills the requirements, and receives a competition license, will carry the "Rookie" title, as defined by this section. A driver on Rookie status must comply with all of the following (sections 13.2.1 and 13.2.2).

13.2.1 Rookie Markings

The driver must display the letter "R" (legibly) next to their car numbers on each side, and on the rear, of the car. The "R" on each side, and the rear shall be three inches (3") high.

13.2.2 Rookie Plate

Drivers with less than eight (8) races must mark the rear of their vehicle with a bright orange mark. The mark must be clearly visible to other vehicles while on track and shall be at least forty eight (48) square inches.

13.3 Provisional License Revocation

The Race Director or the Regional Director may revoke a Provisional License for any reason. Any of the following may be cause for automatic revocation:

1. Any outstanding debt thirty (30) days overdue to NASA, any NASA Region, regional; sponsor, or affiliate.
2. Violating any safety rule found in the CCR.
3. Unsportsmanlike conduct.
4. Disobeying a direct order from a NASA Official.
5. Any driving rule violations or misconduct, on or off the track.

14 NASA COMPETITION LICENSE

14.1 Issuance of NASA Competition License

NASA Competition Licenses are only issued from the NASA National Office and are honored by all Regions. The National Office and its respective regions will evaluate each candidate on a case by case basis and may issue a Competition License providing that the license candidate meets one of the following sets of conditions:

14.1.1 NASA completed Provisional License holders:

1. Submit their completed Provisional License to their regional office.
2. Submit an Application for Competition License

14.1.2 FIA, IMSA, SRO, SCCA, BMW Club, PCA license holders

Regional, National, Pro:

1. Submit an official license application. (<https://form.jotform.com/drivenasa/license-application>)
2. Submit a copy of their current license.
3. Submit a copy of their state driver's license.
4. Submit a copy of their last Physical Exam Form.
5. Submit the appropriate license fee.
6. Submit an Application for Competition License

14.2 Waiver of License Requirements

The Regional Director may grant a temporary Waiver of License Requirements under one of the following conditions (per Region only):

1. It is the driver's first race event of the NASA region and he/she shows proof of a currently valid road racing license issued by an organization listed in section 14.1.2.
2. If the driver has completed the NASA Race Licensing Certification and has been approved by the Region's Licensing Instructor for a Provisional License.
3. If the driver is part of a "Co-Sanctioned Group," or guest group, that holds a currently valid license with that group. This is a one-event waiver.
4. Except for case number three above, the driver must submit all required paperwork and fees for a NASA license before driving in the event. Conditions one to three in this section are simply meant to waive the requirement for possession of a NASA license due to the lead-time required to obtain a physical license.

14.3 License Renewal/Expiration

Competition licenses are valid for the calendar year indicated on the license. The competitor is responsible to keep his/her license current. It is recommended that licenses be renewed at least 30 days before the first event entered, in order to allow time for processing. Drivers that let their licenses lapse for more than 12 months will need to be reapproved.

14.4 Express Handling Fee

A special handling fee of \$80, in addition to the normal charges, is required for 4-8 business-days expedited handling. Drivers will be charged \$150, in addition to normal charges, for 72-hour handling. This does not apply to anyone that had never possessed a NASA completion license or provisional license.

RACING

14.5 License Revocation or Suspension

The Race Director or the Regional Director may suspend a competition license for any reason, for a maximum of one (1) year. The Executive Director may approve harsher penalties upon request. The National Office may suspend a license for any length of time for any reason. A suspended license will not be honored at any NASA sanctioned event. A revoked license will become void nationally and may no longer be used. After license revocation, a competitor may reapply for a license providing:

1. They are not on probation with any NASA Region.
2. They have no outstanding debts with any NASA office.
3. All fines are paid and all outstanding penalties have been served.
4. They are not involved in any pending appeals.
5. They have not been in any litigation with NASA, or any NASA Region, at any time in the past.
6. The Regional Director receiving the new application approves it.

14.6 False Information

Any driver that obtains a competition license by providing false information, pertaining to, but not limited to, name, past history, state driver's license, or medical form may be permanently ejected from NASA.

14.6.1 Aliases

Any driver wishing to use an alias name for purposes of privacy (e.g. celebrity) may be granted such approval with written permission from the National Office.

RACING

15 REQUIRED SAFETY EQUIPMENT

Disclaimer: These regulations must be strictly followed. Conformance to these regulations is the driver's responsibility. These regulations do not guarantee or imply that injuries or death will not occur. If there are any questions or problems with these regulations it is the reader's responsibility to contact the NASA office immediately.

15.1 Fire Extinguisher

A fire extinguisher is recommended in addition to the required fire system. If used, an extinguisher must be securely mounted inside within driver's reach while normally seated, belts fastened, and steering wheel in place. The bracket shall be metal and of the quick release type. The mounting hardware shall use metal bolts/nuts/washers (Use of sheet metal screws and / or rivets is prohibited).

15.2 Fire System

A fire system meeting SFI specification 17.1 or 17.2, or those listed by the FIA on Technical List No. 16 with a visible SFI or FIA certification decal is required. This system shall include a minimum of two (2) nozzles, one (1) in cockpit and one (1) in engine bay, with manual or auto activation. If equipped for manual activation, an activation point (cable pull or switch) must be located inside the vehicle within reach of the driver while normally seated, belts fastened, and steering wheel in place. If an electric solenoid or switch is used to activate the fire suppression system, it should not lose power when the electrical master switch or vehicle ignition switch is turned off. System cylinders shall be securely mounted with metal bolts/nuts/washers. All systems must be installed, maintained, and used per manufacturer's instructions.

15.3 Fire System Required Decal

Vehicles must display two (2) "E" decals, one (1) required inside at the fire system activation point, and one (1) on the outside of the vehicle closest to where the activation switch is most accessible from the outside. This decal indicates to someone assisting the driver where the easiest access point is located. For vehicles with an additional external activation point, an additional "E" decal shall be placed adjacent to that activation point.

15.4 Fuel Cell / Tank

All fuel cells must be FIA FT3 (or higher) certified.

A fuel cell is not required, except as specified by class rules. All vehicles having a fuel cell must comply with the rules in this section, even if a fuel cell is not required by the class rules.

1. There should be a solid bulkhead completely separating the fuel tank, fuel pump, fuel cell, filler neck hoses, and vent lines, from the driver compartment.
2. The cell must contain a bladder that is FIA FT-3 (or higher) rated.
3. The cell should be in a container made of at least 0.036-inch steel, 0.059-inch aluminum, or 0.125-inch Marlex (crystalline polypropylene or high-density polyethylene), fully surrounding the bladder.
4. Internal foam baffling should be installed, as per FIA FT3-1999 (or higher).
5. The filler cap, line, vents hoses, etc. should be designed so that no fuel will escape if the car is partially or totally inverted.
6. There may be a small drain hole in the outside box to purge fuel trapped between the bladder and the box.

RACING

7. The competitor is responsible for ensuring that the cell, bladder, and components are installed, maintained, and replaced per the manufacturer's instructions and in accordance with applicable sections of the CCR.
8. The bladder has a date of manufacture and serial number. The competitor is responsible to note this in the front of the vehicle logbook.
9. Bladders older than 5 years should not be used.
10. The competitor is responsible for showing proof of the age of the bladder. It is highly recommended that the receipt for the purchase of the bladder (or entire cell) be stored with the Vehicle Logbook.
11. A single external (to the fuel tank or fuel cell) container that fuel is stored in, or moves through, (e.g. swirl pots, vent cans, surge tanks, etc.) may be used, and that container shall not have a capacity greater than 1.5 liter (0.4 gallons). The container must be constructed of metal with threaded fittings to stainless steel braided fuel hoses. It must be separated from the driver's compartment by a separate bulkhead. Any container over 1.5 liters (0.4 gallons) is considered to be another fuel cell and subject to fuel cell requirements.

15.4.1 Installation

Reinforcements may be added to aid in the installation of the cell, but they shall not attach to the roll cage. Floor structure may be modified to aid in the installation of the cell. Steel location strapping is strongly recommended to keep the fuel cell from dislocating in a crash. Installing a fuel cell that hangs significantly close to the ground or one that is mounted closest to the rear of the vehicle, even if the installation meets with these rules, may be deemed unsafe and therefore excluded from competition.

15.4.2 Rotary-molded cells

Rotary-molded cells are prohibited unless the bladder meets the current FIA FT3 specifications and carries the current FIA FT3 standard certification mark, label, or stamp. Most or all JAZ and RCI brand cells are examples of rotary-molded **cells that do not carry such ratings.** [Notes: A good fuel cell is made by companies such as ATL or Fuel Safe (other than their entry level models) and should cost \$800 or more. Beware of inexpensive "SCCA APPROVED" cells. While SCCA is a fine organization, the stamp of approval found on some safety items may pertain to other forms of racing and may not be consistent with these rules. Consult an expert before purchase.]

15.4.3 Fuel Cell for Alternative Liquid Fuels

According to leading manufacturers of fuel cells, there is no problem putting alternative fuels into a fuel cell made for gasoline. However, if the cell was previously used for a different fuel, such as gasoline, the bladder should be rinsed, and the foam should be changed. The same is true when switching from an alternative fuel back to gasoline.

15.5 Driver restraint system

(See diagrams at end of section)

1. All vehicles should have a five (5), six (6), or seven (7) point seat belt system. Arm restraints are required in open cars and cars with: Open T-tops, Open Targa tops, missing moon/sunroofs, or glass moon/sun roofs.
2. A five (5) point system consists of: a lap belt, two (2) shoulder belts, and anti-submarine strap.
3. A six (6) point system is recommended for cars where the driver is seated in an upright (to thirty (30) degrees) or a semi-reclining position. It consists of two (2) anti-submarine belts in addition to lap and shoulder belts.
4. A seven (7) point system is recommended for seats with more than thirty (30) degrees of incline.
5. The material of all straps should be in new or perfect condition. The buckles should be metal quick release. There must be a single point of release for all belts.

RACING

6. The shoulder harness should be mounted behind the driver *at an angle between zero (0) as to be level with the driver's shoulders* and above a line drawn downward from the shoulder point at an angle of no more than twenty (20) degrees from horizontal with respect to flat ground.
7. The seat, seat holes, and attachments to the seat, are not permissible "harness guides" for compliance with the angle requirement. Only specific harness guide bars, or parts of the chassis or the cage are permitted for this purpose. The guide bar, if used, should not present a sharp edge to the belt. It should provide as much area of support as possible to distribute the load.
8. Only separate shoulder straps are permitted. "H" type belts are permitted. "Y" type belts are Prohibited. Each shoulder strap should have an independent mounting point.
9. All mounting hardware should be SAE grade five (5) or better. Large diameter mounting washers should be used to spread the load. Bolting through floor panels etc. is prohibited without required washers.
10. Certain belt sets are made for certain purposes, such as for use with a specific head and neck restraint device. The driver is responsible for ensuring the use of the proper belt set for his/her given application. In addition, all belts must meet at least one of the following:
 - A) SFI Specification 16.1 or 16.5 and shall bear a dated label of no more than two (2) years old or show an expiration date (starting on belts produced in in 2017). At least one date label is required on belt sets.
 - B) A restraint system meeting FIA 8853/98, or D-###.T/98, or higher, including amendment 1/92 may be used. FIA certified belts have a label that shows an expiration date. The belts cannot be used past December 31st of the year shown on the label. At least one date label is required on belt sets.
11. All drivers should take care to ensure that their belts are properly worn, adjusted, and latched. It is the driver's responsibility to assure that harnesses are installed in compliance with manufacturer's instructions for the harness as well as their head / neck restraint.
12. Any driver involved in a high impact crash shall send all of their safety belts back to the manufacturer for inspection, re-webbing if necessary, and re-certification before they may be used again in competition. Proof of re-certification is the driver's responsibility.
13. All belts should be threaded in compliance with manufacturer's instructions. An example of one type of threading instruction set appears at end of this section.

Typical Harness Threading Diagram

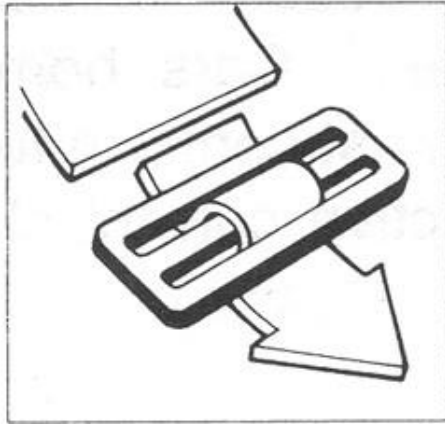

STEP 1: Insert strap through tightening buckle

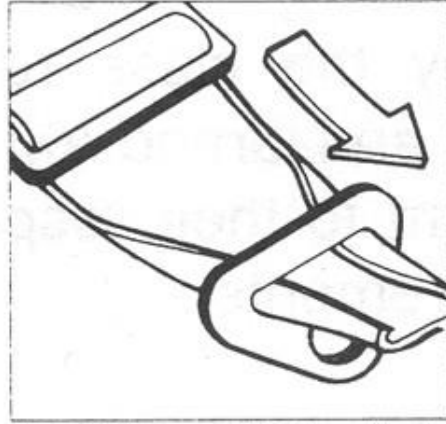

STEP 2: Pull strap to 8"-10" beyond buckle, fold edges and insert into mounting bracket

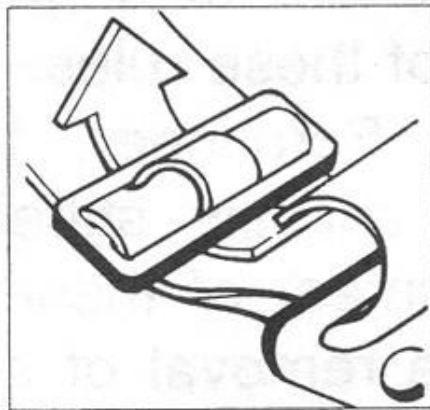

STEP 3: Fold back strap and re-insert through buckle as shown.

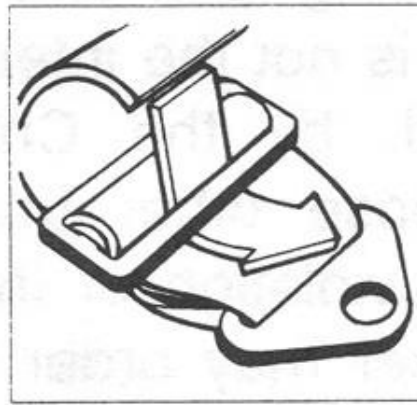

STEP 4: Fold back strap again and insert through bottom portion of buckle

RACING

15.6 Roll Cage

(See diagram at end of section)

15.6.1 Purpose

The basic purpose of the roll cage is to protect the occupant in case of a rollover or a collision.

15.6.2 Chassis Stiffening

Chassis stiffening is a side benefit of a good roll cage system, but it is not the intent of these rules. Parts of the cage deemed by the Chief Scrutineer to serve no practical purpose other than chassis stiffening may be considered in violation of the intent of these rules.

15.6.3 Installation

The cage may be removable or may be permanently welded, or any combination thereof, providing that all aspects of the cage meet these rules.

15.6.4 Padding

All roll cage surfaces that may come in contact with the driver's head, knees, and elbows must be padded with high-density padding such as Ethafoam or Ensolite or other material labeled "high density padding" and manufactured for road racing use.

15.6.5 Bends

None of the tubing may show any signs of crimping or wall failure. All bends should be Mandrel type. The center radius of the bends should not be less than three (3) times the outside diameter of the roll cage tubing.

15.6.6 Main Hoop

The main roll cage hoop should be as wide as the full width of the interior and must be as close to the roof as possible without violating CCR section #15.6.23. One continuous length of roll bar tubing shall be used as the main hoop. The main hoop must consist of not more than four (4) bends* maximum, totaling one hundred eighty (180) degrees +/- ten (10) degrees. *Any slight bend at the midline of the roof to ensure compliance with this section is not considered a bend for the purposes of this section.

15.6.7 Diagonal Brace

One (1) diagonal brace should be used in the same plane as the main hoop. The diagonal should be one continuous path; meaning that it must conform to Diagrams 15.6.7a or 15.6.7b. Note- If the installation method from Diagram 15.6.7b is used, the builder should pay close attention to alignment. One end of the diagonal brace shall attach to the corner, or horizontal part of the main hoop above the driver's head, within twelve (12) inches of the driver's-side corner. The other end of the diagonal brace shall attach to the mounting plate (or to the main hoop as close to the mounting plate as practically possible) diagonally opposed to the driver's head (passenger floor).

15.6.8 Forward Hoops (Option 1)

The forward hoops should extend from the main hoop (in a forward direction) to the floor by following the roof and the "A" pillar of the car. There should be a bar connecting the two (2) forward hoops at the top of the windshield mounted as close to the roof as possible without violating CCR Section #15.6.23. The forward hoops should incorporate no more than four bends each. Optionally a "15.6.9 Halo Hoop (Option 2)" or "15.6.10 Front Hoop (Option 3)" construction may also be acceptable.

RACING

15.6.9 Halo Hoop (Option 2)

A “halo bar” extends from the main hoop (in a forward direction) following the roof line to the windshield then following along the top of the windshield, then following the roof line back to the main hoop, thus creating a “halo” over the driver’s head. A “halo” bar should be constructed of one (1) continuous piece of tubing. One (1) down tube following the “A” pillar should support the “halo” on each side of the car. The down tubes shall incorporate no more than two (2) bends each.

15.6.10 Front Hoop (Option 3)

A “front hoop” is a bar that extends up from the floor, then follows the “A” pillar up to the roof, then follows the roof line across the top of the windshield, then back down the other “A” pillar, and then terminates on the floor. There should be one (1) horizontal bar (following the roof line) connecting the main hoop and the forward hoop on each side of the car. The front hoop should incorporate no more than four (4) bends.

15.6.11 Rear Braces (see diagram at the end of section)

The main hoop should have two (2) braces extending to the rear. The braces shall be attached as near as possible to the top of the main hoop, and no more than six (6) inches below the top. **The braces should not contain any bends***. There must be at least 30 degrees between the plane of the main hoop and the plane of the rear braces. The main hoop rear braces may consist of an “X” pattern design. The main hoop braces may be mounted at the rear shock mounts or suspension pickup points (providing that the braces remain in compliance with all other sections of the CCR). They may go through any rear bulkhead(s) provided the bulkhead(s) is sealed around the cage braces. *There may be certain exceptions allowed for cars that cannot possible meet this “no bend” requirement. One exception is listed [Ref:(15.6.12)]. Other exceptions may be made if all of the required bars meet the specifications for a vehicle in the next heavier weight classification and the alternative design is submitted to the NASA National Office for special allowance.

15.6.12 Rear Braces - Exceptions

On cars where the rear window/bulkhead prohibits the installation of rear braces (Porsche 914, Pontiac Fiero, etc.) the main hoop should be attached to the body by plates welded to the cage and attached to the stock shoulder harness mounting location. There must also be a diagonal bar connecting the top of the main hoop to the lower front passenger side mounting point (“Petty bar”). Some cars built for racing in other recognized sanctioning bodies may be granted a waiver of this rule; however, they must show proof of compliance with the current published rules for their class.

15.6.13 Door Bars / Side Impact Protection

At least two (2) door bars on the driver side and one (1) door bar on the passenger side are required in all vehicles. Note- an “X” design is considered to be two bars. One (1) optional door-bar support tube may be installed from the door bar(s) to a single point on a plate attached to the rocker panel. This applies to both side of the vehicle. The mounting plate shall be no larger than twenty-five (25) square inches and measure more than eight (8) inches in any direction. This mounting plate must not serve any other purpose than serving as the termination point for the additional support bar.

Unless superseded by class rules, modifications to any non-chassis structure (such as door panels, inner door sheet metal, windows, door internals, etc.) may be made to accommodate any allowed door bar configuration. However, removal of material and / or modifications is limited to 1) the least amount to accommodate the door bar(s), and 2) can serve no other function. Holes, or notches, in the door jamb (B-pillar) are permitted to accommodate door bars.

15.6.14 Mounting Points

The roll cage shall be mounted to the floor area, which includes rocker panels, of the car in six, seven, or eight points. The cage shall not go through the firewall. The seventh and eighth points must attach to the firewall or

RACING

front fender wells. All cage attachment points must be mounted to plates or a mounting box (plinth). Each required cage bar shall terminate on a plate with a 360 degree weld to the mounting plate, except as specified in Section 15.6.17. There shall be only one (1) mounting "point" per plate. This point is defined as where the "required tube" mounts. All additional tubes mounted to that plate must be mounted as close to the required tube as possible [Ref: (15.6.17)]. It is recommended that plinth boxes use a bottom support plate in cases where the edges of the box may punch through the sheet metal.

15.6.15 Mounting Plates

Each mounting plate shall be no greater than one hundred (100) square inches, and no less than nine (9) square inches. Each mounting plate must be no greater than twelve (12) inches or less than two (2) inches on any side. Welded mounting plates shall be at least 0.080-inch thick. Plates may extend onto vertical sections of the structure. Any mounting plate may be multi-angled but shall not exceed one hundred (100) square inches total including vertical sections.

15.6.16 Mounting Plates – Bolt-In Cage

The attaching points of a bolt-in cage to the body must use reinforcing plates to sandwich the body. At least three (3) bolts are required for each bolt-in plate and the plate must be at least 3/16 inch thick. All hardware must be SAE Grade five (5) or better with 5/16" diameter minimum. All nuts must be held securely by a locking system such as safety wire, lock washer, Nylock, or jam-nuts. Nylock or nuts that use metal crimping to prevent loosening shall not be reused.

15.6.17 Tube / Mounting Plate Specifications

Any number of tubes may attach to a plate so long as they are touching each other at the plate. There may be a small gap between tubes to allow welding 360 degrees around each tube. If there is no gap between the tubes, they must be welded around the base as much as possible to form a single figure-eight weld, and the tubes must be welded to each other for two (2) inches up from the base plate.

15.6.18 Welds

All welding must be of the highest quality with full penetration. All tubes must be welded 360-degrees around the circumference of the tube. Tubes in cages produced and installed at the factory (not dealer) may be permitted without some welds not being 360 degrees. Example: Porsche GT3 Cup Car. This is a factory-built racecar with the cage already installed.

15.6.19 Tube Structure Design / Body

Tubes may touch the body in any place (not to violate CCR section #15.6.23 Inspection), but shall not be attached anywhere except as permitted by CCR Section #15.6.12 Rear Braces - Exceptions. No deformation of the interior body panels is permitted, except that the horizontal part of the sheet metal (next to the driver's and/or passenger's head) between the top of the "B" pillar and the top of the "A" pillar, may be pushed in to accommodate the roll cage. The intent of this permitted deformation is strictly to allow for more headroom for the driver and/or passenger.

15.6.20 Additional Reinforcement

Any number of additional reinforcing bars are permitted within the structure of the cage provided that they are installed strictly for safety and do not violate CCR Section #[15.6.2](#). This rule does not permit reinforcements in classes with spec cages.

All required bars must be made of the same material and meet with at least the minimum specifications for size and thickness. Additional tubing may be of any size / dimension; however, it should not create an unsafe situation.

RACING

15.6.21 Roll Cage Tubing Sizes

For the purposes of determining roll bar tubing sizes, the vehicle weight is as raced, but without fuel and driver. Note: There is an allowance of minus 0.010 inches on all tubing thicknesses to account for manufacturing tolerances. Minimum tubing size for the roll cage is:

Up to 1500 lbs

1.375" x 0.095" Seamless Alloy (4130), Seamless mild steel (CDS Mechanical), DOM, or Docol R8 (only)

1.500" x 0.080" Seamless Alloy (4130), Seamless mild steel (CDS Mechanical), DOM, or Docol R8 (only)

1501 - 2500 lbs

1.500" x 0.095" Seamless Alloy (4130), Seamless mild steel (CDS Mechanical), DOM, or Docol R8 (only)

1.500" x 0.120" ERW* (No issuance of logbooks for cars with *ERW* cages) *Note- Specifications listed only for reference for inspection of grandfathered vehicles.

2501 - 3000 lbs

1.500" x 0.120" Seamless Alloy (4130), Seamless mild steel (CDS Mechanical), DOM, or Docol R8 (only)

1.750" x 0.095" Seamless Alloy (4130), Seamless mild steel (CDS Mechanical), DOM, or Docol R8 (only)

1.750" x 0.120" ERW* (No issuance of logbooks for cars with *ERW* cages) *Note- Specifications listed only for reference for inspection of grandfathered vehicles.

3001 - 4000 lbs

1.750" x .120" Seamless Alloy (4130), Seamless mild steel (CDS Mechanical), DOM, or Docol R8 (only)

No ERW allowed.

Over 4000 lbs

2.000" x 0.120" Seamless Alloy (4130), Seamless mild steel (CDS Mechanical), DOM, or Docol R8 (only)

No ERW allowed.

15.6.22 Bending Allowances

If the maximum number of bends permitted for any one bar is exceeded, all required components shall be made from the tubing size listed for the next heavier category.

15.6.23 Inspection

Wall thickness will be determined using a tool such as a sonic tester. Alternatively, a 3/16 inch inspection hole may be drilled-in each of the required bars in a non-critical area for the purpose of determining wall thickness. Determination of wall thickness and means of testing will be noted in vehicle logbook. All welds, except those mounted to plates on the floor, must be accessible for inspection (360 degrees).

15.6.24 Seat Back Support

A seatback support must be made to hold the seatback from failing in the event of a crash. A plate shall be used to distribute the load. No bolts, corners, or sharp objects should be placed in such a manner that could lead to a possible puncture of the driver in a high impact crash. Seat back support need not be attached to the seat itself. Proper design and installation are crucial to safety, and it is recommended that the driver employ the services of a professional race car builder for this, as well as all other vehicle safety items. An exception may be made for those seats homologated to, and mounted in accordance with, FIA 8855-1999 or 8862-2009 standards. Those seats that qualify for the aforementioned exception must conform to the entire FIA 8855-1999 or 8862-2009 set of regulations, as applicable. This includes a mandatory seat replacement, or use of a seat back brace, for any seat more than five (5) years old (8855-1999) or more than ten (10) years old (8862-2009). Please reference the FIA regulations. <http://www.fia.com/>. Seatback supports should be located as shown below.

RACING

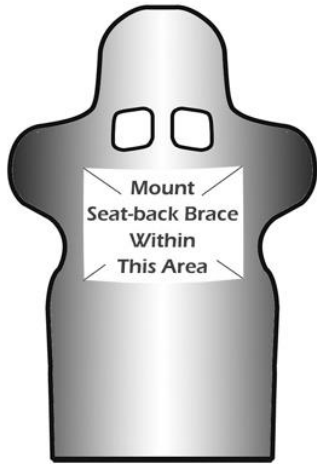

Diagram courtesy of I/O Port Racing.

15.6.25 Shoulder Harness Bar

The shoulder harness bar shown in the cage diagram (below) as bar “H” – “G” must meet the minimum dimensions required for the cage design for the specific vehicle. The harness bar need not intersect the main hoop at any specific location (vertically) however the bar shall be installed horizontally (parallel with the ground). The bar should intersect the required diagonal bar, but need not remain in the same plane as the main hoop (e.g., May bend aft-ward to allow more seat room behind the driver and /or passenger seat(s)). If the harness bar does not intersect the required diagonal bar, a bar meeting the same minimum dimensions required for the cage design must be installed horizontally (parallel with the ground) at the point the two bars would have intersected if not for the rearward bends in the harness bar that prevented them from intersecting.

RACING

15.6.26 DIAGONAL BAR DIAGRAMS

ROLL CAGE DIAGRAM

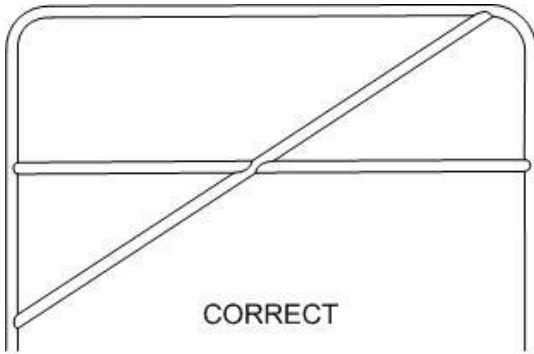

CORRECT

Figure 15.6.7a

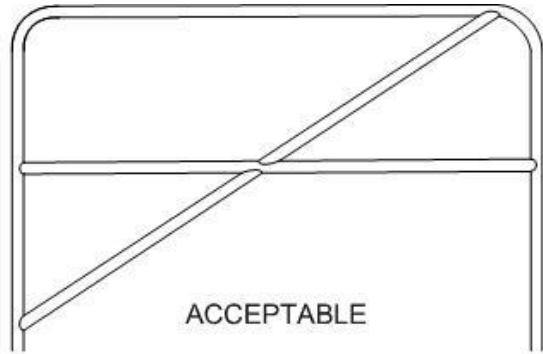

ACCEPTABLE

Figure 15.6.7b

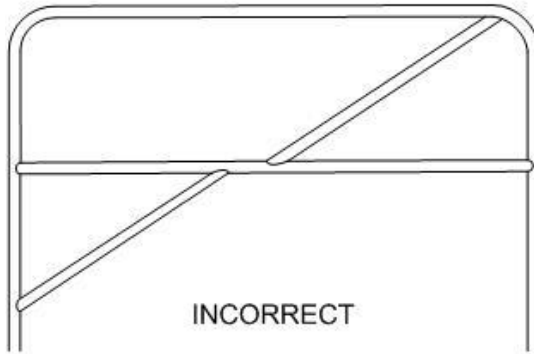

INCORRECT

Figure 15.6.7c

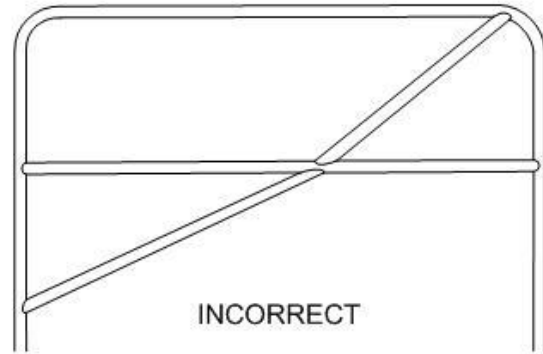

INCORRECT

Figure 15.6.7d

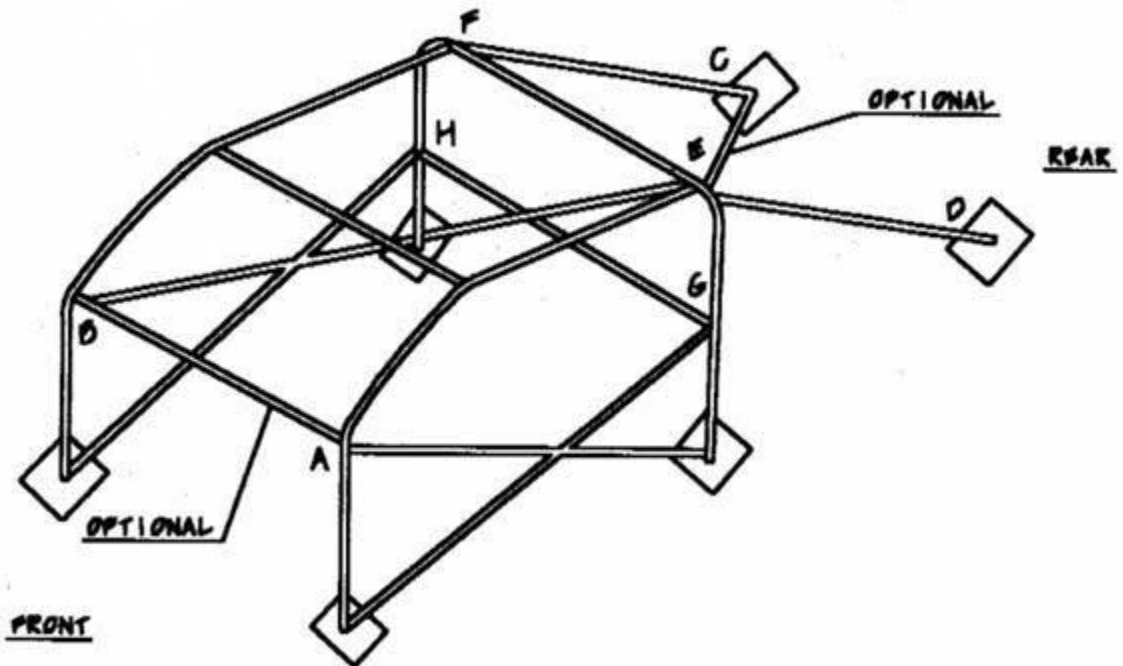

TYPICAL ROLL CAGE

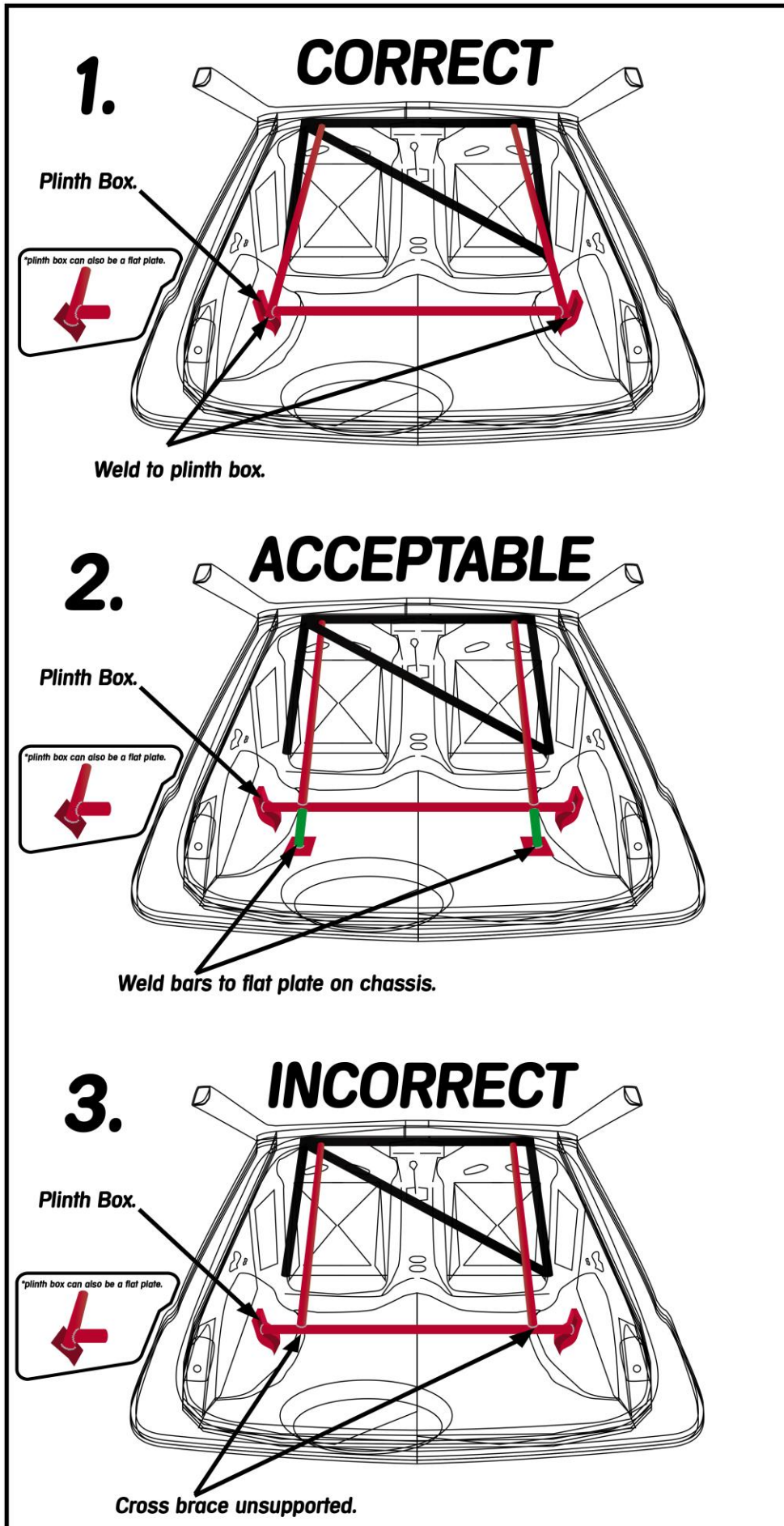

RACING

15.7 Disability Operated - Controls

All vehicles with special controls are the responsibility of the driver. NASA will not assume any liability for poor design and /or failure of any such mechanism. As such, NASA cannot provide approval or disapproval for the design or method of operation. However, vehicles driven in an unsafe manner may be removed from the track regardless of the cause.

15.8 Master Switch

An electrical master switch is required. It should be mounted so that it is easily accessible from the outside of the vehicle. If mounted outside the vehicle, it should be mounted in an area where it is least likely to be damaged (e.g. cowling near wipers). The switch should shut off the engine and cut all power except to the on-board fire system, radio communication, and any other life support / medical device. The switch location must be clearly marked with a master switch cut-off decal.

15.9 Steering Wheel Lock

The steering wheel locks shall be removed or disabled.

15.10 Windows / Window Nets

Vehicles shall be operated with both side glass windows fully open *except for cases where the vehicle was originally designed and delivered with factory installed lexan side windows.*

Window nets shall be used on the driver's side window. The net shall be installed with a quick release mechanism at the top front mount so as to allow the window net to fall toward the floor of the vehicle when released. Fasteners must be metal and must be attached to the roll cage, and not the door or body. Drilling holes in the roll cage to mount the window net is strictly prohibited unless properly "bushed." Plastic ties or Bungee (type) cords prohibited. The window net *shall* ~~must be less than five (5) years old,~~ carry an SFI **27.1** or FIA label, and be in very good condition.

Exception: Vehicles originally designed for use on closed course circuit driving with manufacturer installed window nets may utilize the original equipment. Note: It is the responsibility of the participant to provide evidence that the vehicle is as delivered from the manufacturer.

15.11 Camera Mounts

Camera mounts are unrestricted providing that they serve no other purpose.

15.12 Tow Eyes

It is **required** that all race vehicles, except formula cars, have at least two (2) easily accessible (and usable) tow eyes, or tow points; one (1) in front and one (1) in back. They must not protrude dangerously from the car or require manipulation of the bodywork and/or panels to access the tow eyes. If tow eyes or tow points are not available the towing crew will hook onto other things that may cause damage to the driver's car. The tow crew and NASA will not be held liable for any damage.

RACING

15.13 Windshield / Sunroof Clips, Headlights

Windshield clips are recommended to hold the windshield from ejecting in case of a crash. Sunroof clips are required. Glass sunroofs (moon roofs) must be removed or completely covered with tape on both sides. Taping to protect headlights from rocks is recommended.

15.14 Hoses Inside Cockpit

All hoses carrying any flammable liquids or any toxic or flammable gases that go through the cockpit must be metal or steel braided or reinforced.

15.15 Lights

15.15.1 Brake

There should be at least two (2) working red brake lights visible from 300 feet to the rear. Certain racecars may be exempt at the discretion of the Event Director.

15.15.2 Headlights

Headlights are not specifically required, unless class / series rules specify use.

15.15.3 Rain Light

Optionally, some regions may require rain-lights be used. A rain light is a steady-burning, rear-facing, red light used for better visibility during wet sessions. Drivers should check with the hosting region's supplemental regulations. If the region staff or management determines a light to be insufficient, the driver should receive a notation in the vehicle's logbook to fix it for future events.

15.16 Driver's Seat

The driver's seat must be securely fastened and braced in such a way as to minimize the possibility of breaking loose during an impact. Large fender washers and solid fabricated mounts are recommended. Seats made primarily of plastic, polymer, PVC, ABS, or other similar materials are prohibited. Fiberglass / carbon fiber / Kevlar seats made for road racing are permitted. The installation of the seat must conform to all requirements published by the manufacturer.

15.16.1 Racing Seat

A seat is required. A racing seat is of solid design; not "tube and cloth" designs commonly found in passenger cars. It can be very difficult to properly brace a "tube and cloth" type seat and the vehicle may not pass technical inspection.

15.16.2 Seat Mounting

The seat shall be mounted to a steel floor pan with reinforcements or mounted through a frame member(s) and/or additionally added reinforcement. A reinforcement structure should be fabricated with a minimum thickness of 0.090" for those vehicles without a steel floor pan. The reinforcement structure should be mounted to (or within) the steel frame / chassis / cage members.

RACING

15.17 Driver's Attire

The following safety items should be worn by the driver to participate in any competitive session. All equipment shall be in a state of good condition. All defects, holes, tears, cracks, and other damage shall be repaired. Drivers' racing attire and belts will be subject to random safety inspections at any time while at the race facility. If, at any time, illegal, non-conforming, missing, or outdated safety equipment is found, the equipment (in its entirety) will become the property of NASA. Additionally, the driver may be fined \$50 for each separate offense. Subsequent offenses during the same season will double the penalty each time. NASA reserves the right to make the penalties more severe should the situation warrant.

15.17.1 Driving Suits

A driver is required to wear a suit that covers his or her entire body except for hands, feet, and head. Driving suits shall be one piece carrying an SFI 3.2A/1 rating or higher (3.2A/5, 3.2A/10, 3.2A/15, or 3.2A/20) or FIA 8856-2000, FIA NORME 1986/1986. The minimum driving suit requirement for vehicles using any type of diesel or diesel mixture is 3.2A/5, or higher. Note "3.4" is an acceptable substitute where "3.2" is used and / or listed.

15.17.2 Underwear

Long underwear made of fire-resistant material must be worn with all suits except those carrying a rating of SFI 3.2A/5, 3.2A/10, 3.2A/15, 3.2A/20 or FIA 8856-2000. Underwear certified to SFI 3.3 or FIA 8856-2000 is strongly recommended in all cases. All drivers using any type of diesel or diesel mixture must wear long underwear made of fire-resistant material, if the suit rating is less than 3.2A/10. Note- other types of fuel may require higher ratings.

15.17.3 Helmet

All drivers are required to wear a properly fitted and secured helmet while on track. Helmets must be approved by Snell and carry a sticker of Snell SA2015, EA2016, or newer*. Ratings other than that of "SA" (Special Application), (e.g. M2015, M2020, or CMR2007), **are not acceptable**. *Alternatively, helmets with an FIA certification of FIA 8858-2002, FIA 8859-2010, or FIA 8860-2010 or newer are acceptable. It is strongly recommended that any helmet sustaining any substantial impact be replaced.

15.17.4 Gloves

Drivers shall wear gloves made from fire resistant material that fully covers the hands and leave no exposed skin when worn with the driving suit.

15.17.5 Eye and Face protection

A full-face helmet with an impact-resistant face shield is required in "open" cars (FFR, sports racers, and formula cars) and highly recommended for all vehicles. Eye protection is required. Face shields, safety glasses, or goggles completely made of impact resistant material are permitted as "eye protection." However, the choice of eye protection used, and the responsibility for any failure, belongs to the driver. Drivers with beards or long hair should, at their discretion, also wear a face cover (balaclava) made of approved fire-resistant materials. A full helmet skirt made of Nomex or other fire-resistant material shall also satisfy this rule.

15.17.6 Shoes

Shoes made of fire-resistant material or common cowhide leather are required. Shoes must cover the entire foot so that there are no exposed areas of skin.

15.17.7 Socks

Socks made of fire-resistant material must be worn.

RACING

15.17.8 Head and Neck Restraint

Use of a head and neck restraint system or device, carrying an SFI 38.1, FIA 8858-2002, or FIA 8858-2010 (or higher) certification label, is mandatory for all drivers. References and information can be found in “Appendix D,” section #29 of the CCR.

15.17.9 Head Restraint – Side Impact

All vehicles, except formula cars, must be outfitted with a right-side impact head restraint system. A seat with a “bolster” to keep the head from moving to the right side in an impact is acceptable. A side-impact head-net restraint system, such as shown in picture 15.17.9-2 below, is also acceptable. Note- all side-impact head-net restraint systems must have a quick-release mechanism to aid the driver in case of egress if necessary, via the passenger side.

Note- it is recommended that a side net wrap around the seat and function to help stop the shoulders, head bolster (if applicable), and seat from moving sideways in an impact. It is best to follow the manufacturer’s recommendations for installation of any safety device. However, in lieu of such recommendations, or in addition to, it is recommended that the lower strap of the side net run parallel with the fore/aft center line of the car and be low enough to support the shoulder area as well. Furthermore, it is suggested that the top strap follow a path through the center of the helmet, when viewed from the side. Reference Diagram 15.17.9-1

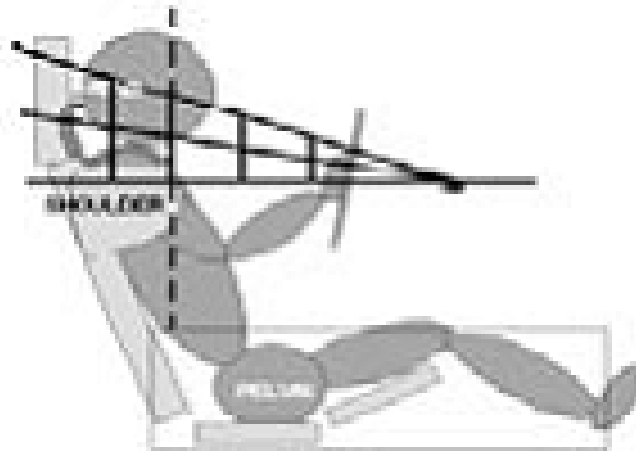
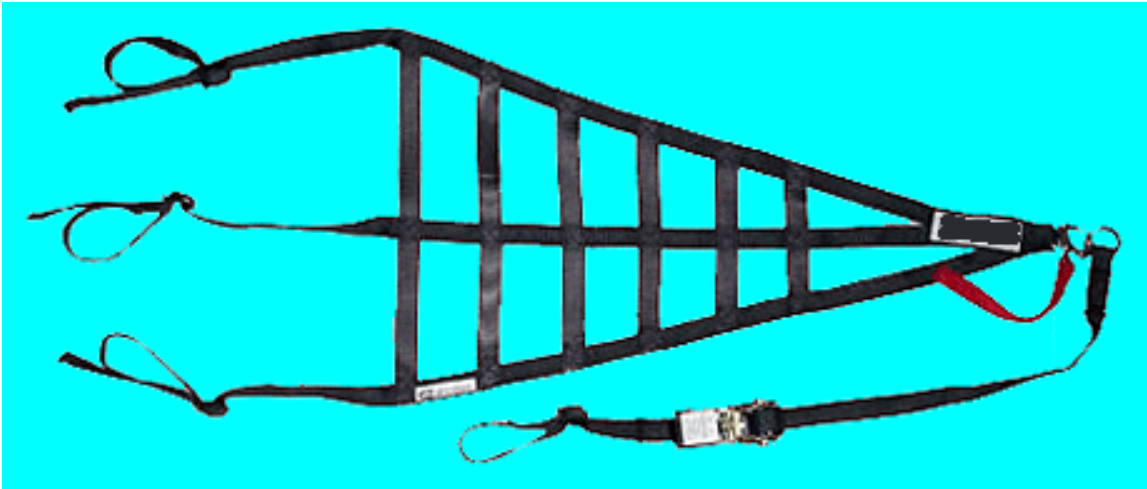

Diagram 15.17.9-1

RACING



Picture 15.17.9-2

15.18 Engine Coolant

Glycol-based antifreeze and other additives that may cause a slippery condition if spilled on track are prohibited. Other water additives such as Redline Water Wetter may be used.

15.19 Alcohol Injection (where permitted by class rules)

Tanks containing alcohol (e.g. methanol) that exceed 50% alcohol by volume must carry an FIA FT3 (or higher) rating and be installed per fuel cell regulations found in CCR Section [Ref:([15.4](#))]. Tanks containing 50% or less alcohol by volume may use any container per the manufacturer's instructions or recommendations. Under all circumstances tanks and / or containers must be mounted in an area that is separated from the driver by a solid bulkhead or firewall.

15.20 Ballast

All ballast shall be solid metal such as steel, lead, or depleted uranium, and consist of a minimum of five (5) pounds per piece. Each piece shall be bolted in place with through-bolts, fender washers, and a locking-nut / system (e.g. jam-nuts, Nylock, etc.). All ballast shall be secured sufficiently, and all bolts shall be of grade five (5). Nylock nuts or metal crimping lock nuts should not be reused.

15.21 Exhaust Exit

The exhaust must exit behind and away from the driver.

15.22 Mandatory Video Camera

All competition vehicles, except Time Trials, are required to use at least one forward-facing video recording device at all times while on the track. The video format must be a digital file such that it can be viewed in an MS Windows compatible viewer. The camera must capture at least the "driver's eye view." Video cameras shall produce files with the correct time and date. Failure to comply with any part of this section will incur penalties as follows: First offense is a warning, second offense is a fifty-dollar (\$50) fine, third offense will result in a one

RACING

(1) race suspension from the series, and fourth offense is racing-license suspension for 365 days. Penalties may be alleviated for bonified mechanical failure, such as crashing, as determined by the Race Director.

15.23 Fuel Caps

All vehicles should utilize fuel caps such that the fuel will not spill out of the fuel tank under hard driving. Operational Monza type caps are prohibited. (Decorative Monza style covers for regular fuel caps are permitted).

15.24 Non-NASA-classed Vehicles Safety Equipment Requirements

Vehicles homologated by, or built to the specifications of FIA Group N, FIA Group C, JAF, SCCA, IMSA, 600 Racing, U.S. Legends Cars, and any others, as deemed by a Regional Director, must conform to their respective current class rules for roll cage and all other safety requirements.

15.25 Electric and Hybrid Powered Vehicles

Vehicles powered, all or in part, by an electric motor, must display four “lightning bolt” decals, as pictured below, in visible locations to warn safety crews of possible high voltage and alternative batteries. There shall be one decal on the door below the driver’s window opening and a corresponding decal on the passenger side. Additionally, decals are required on the front and rear of the vehicle. If the vehicle is non-production-based the decals shall appear as close as practical in the corresponding locations (e.g. bodywork). Decals are found at Registration or may be ordered through NASA-approved vendors.

Diagram 15.25-1



TECHNICAL INSPECTION SECTION

“Inspection helps ensure protection from oversights”

16 VEHICLE SAFETY INSPECTION

16.1 Competition Vehicle Logbook

Each entrant is required to possess, and present upon demand, a current NASA Competition Vehicle Logbook issued for the entered vehicle. Only a NASA authorized Inspector, or inspection shop, can issue a NASA Competition Vehicle Logbook. Only one Competition Vehicle Logbook will be issued per vehicle, unless the original has been lost, and special permission is granted from the NASA Region office. To be eligible for a NASA Competition Vehicle Logbook, the vehicle must meet or exceed all of the requirements listed in this section "16 VEHICLE SAFETY INSPECTION." [Note: Some of the requirements in this section may be waived for cars that meet the current published safety rules for their class listed with another bonafide sanctioning body (e.g. FIA, IMSA, SRO, SCCA), unless otherwise specified by these rules.]

16.2 Annual Safety Inspection

Each calendar year before vehicle's first race, the vehicle must go through a full inspection, which must be done by appointment, by an authorized NASA Tech Official or at one of the NASA authorized competition vehicle tech shops. After completion of each Annual Inspection, the authorized person and or shop must complete an Annual Race Car Technical Form. The driver will present it to the Regional NASA Chief Scrutineer at the first event, before going on track. The NASA Chief Scrutineer will, upon receiving the signed Annual Race Car Technical Form, affix an Annual Tech Sticker, as issued by the National Office. **No car may enter the track for a competitive session unless a required Annual Tech Sticker is affixed to the lowest part of the driver's side of the windshield, if applicable; or on the top of the roll bar in open-cars, without Race Director approval.**

NASA Officials may inspect cars for safety issues at any time. Random safety inspections are common at NASA events, and if any illegal items are found, the competitor will be held accountable.

16.2.1 Re-Inspection- Alteration/Damage

A vehicle must be re-inspected by a Tech Inspector or a NASA authorized shop, if any of the following has occurred:

1. Been involved in a major crash, which includes impacts resulting in a tow.
2. Deemed a new inspection is necessary by indications of notes in the Logbook.
3. Vehicles that have had safety equipment altered or damaged.
4. Missing required Annual Tech Sticker.

16.2.2 Emergency Exit Time

The vehicle should be constructed to allow drivers to exit the vehicle quickly in an emergency. Drivers should be tested from time to time to ensure that they meet the specified time for exiting the vehicle in the event of an emergency. The driver must demonstrate the ability to exit the vehicle within fifteen (15) seconds. Drivers must be wearing all of their required driver's gear and be tightly belted into the driver's seat when the clock starts.

16.3 Safety Inspection at Each Event

All drivers are responsible for inspecting their own cars for each event.

Any driver failing to properly prepare his/her car as required by the CCR and as noted in the Annual Race Car Technical Form may be subject to license revocation, monetary fines, disqualification, and / or other penalties. If, at any time, illegal, non-conforming, missing, or outdated safety equipment is found in or on the car, that equipment (in its entirety) will become the property of NASA and the Annual Tech Sticker may be removed.

RACING

Additionally, the driver may be fined fifty (\$50) dollars for each separate offense. Subsequent offenses during the same season may double the penalty each time. NASA reserves the right to make the penalties more severe should the situation warrant.

Any on-track mechanical failures of parts or systems, that are the competitor's responsibility, as defined by the Annual Race Car Technical Form, will result in a \$50 fine. Each subsequent violation will result in a tripling of the previous fine.

RACING

17 VEHICLE LEGALITY INSPECTION

17.1 Impound

The top four (4) finishing drivers and cars in each class must proceed to impound immediately after the race. Additionally, any vehicles that have lost any body panel(s), had body contact, and/or have lost any parts (e.g. muffler) on track must report to impound. Body Contact Report Forms must be turned in to the Race Director or Tech Official within thirty (30) minutes of the checkered flag. Failing to do so may result in penalties imposed on the driver. If in doubt about finishing positions the vehicle and driver shall report to impound. It is the driver's responsibility to report directly to impound with the vehicle and the vehicle's logbook at the proper time. If it is necessary to stop in the pitlane after the checkered flag, no adjustments to the vehicle are allowed. Taking tire temperatures is permitted.

17.2 Post Race / Qualifying Legality Inspection

Tech Inspectors have the right to inspect anything at any time for any reason.

17.3 Disassembly

Tech Inspectors should not disassemble any part themselves, for liability reasons. Tech inspectors may disassemble parts if needed, for practical reasons. Competitors should have the crew and tools to disassemble requested items. If the competitor isn't prepared to comply, the vehicle or part assemblies may be taken to a shop for compliance checks. If the inspection is being performed as part of the normal impound inspection process the competitor will bear the cost of disassembly and re-assembly.

17.4 Confidentiality

A competitor has a right to protect information about legal modifications and vehicle setup from other competitors. If a competitor feels that inspection by the Tech Inspector (e.g. if the Inspector is another competitor) will result in loss of information to another driver or team, he/she may lodge such an objection with the Tech Inspector. Once an objection has been lodged, the Tech Inspector will remain in impound while the competitor locates the Race Director. The Race Director will then make the determination of legality. The Tech Inspector may watch the vehicle or assign someone to watch it, but shall not conduct any inspections, other than those agreed upon between himself/herself and the driver.

17.5 Protests, Request for Action, and Appeals

17.5.1 Protests

Any entered driver may lodge a protest against another driver disputing the mechanical compliance of their competition vehicle. To lodge a protest, the protestor shall obtain a "*Protest Form*" from Registration, or other designated location, fill it out, and file it, along with the appropriate fee, with the Race Director, or impound officials. The Race Director may accept the protest, may extend the time allowed, or may reject the protest. For the protest to be valid, it must meet the following conditions:

1. Be filed within thirty (30) minutes of the end of the session.
2. Each part that is being protested must be named specifically.
3. Each part may be considered a separate protest, in terms of fees.
4. Each part listed should be accompanied by the rule(s) number that it violates.
5. The title of the rulebook should be cited with each rule number.

RACING

6. Be accepted by the Race Director.

The Race Director reserves the right to modify these rules as cited in CCR section #[21.1](#)

17.5.2 Request For Action (RFA)

Any entered driver may lodge a Request For Action (RFA) against another driver for conduct. The complainant shall obtain a "Request for Action Form" from Registration, fill it out, and file it, along with the appropriate fee, with the Race Director or Series Leader. The RFA Form must be filed within thirty (30) minutes from which the incident occurred, or after the session has concluded, whichever affords more time*. The Race Director may accept the RFA, may extend the time allowed, or may reject the RFA. *RFAs made during an endurance race must be made within thirty (30) minutes of the incident.

17.5.3 Appeals - Regional

Any entered driver may appeal any decision made by any Official. The driver must submit an "Appeal Form," to the Race Director, with the appropriate fee. The Appeal must be filed within thirty (30) minutes from the time when the driver was first notified or by the end of the session (if applicable); whichever allows the driver more time. Drivers who wish to appeal an RFA, vehicle legality, or a penalty for driving conduct (track or paddock), MUST utilize the "Executive Committee" process explained below. All other decisions (not outlined above) have an additional option to utilize an Executive Appeal.

The Race Director will form a panel of no less than three (3) people that are acceptable to the appealing driver. This is called an "Executive Committee." Any decision made by the Executive Committee is final and cannot be overruled.

1. All other decisions (not outlined above) have an additional option to utilize an Executive Appeal. Request that the Event Director forward the Appeal to the Chief Executive Officer. The Event Director shall forward a copy of the appeal form, all documentation in the case, all evidence in the case, and his/her written statements to the Chief Executive Officer. At the NASA Championships, the driver must notify the Chief Executive Officer within thirty (30) minutes of the intention to file an Executive Appeal, if the Chief Executive Officer is at the event. If the Chief Executive Officer is not at the event the Event Director should notify the Chief Executive Officer as soon as possible. The Chief Executive Officer will contact the appellant at his earliest convenience.

17.5.4 Appeals - Executive

Any decision made by the Chief Executive Officer is final. The appellant must submit, in writing, all of the details of the case, including references to all applicable rules, along with any and all evidence, including a copy of original appeal form, and the fee of one hundred fifty (\$150) dollars, to the Chief Executive Officer (in person, if present) or by email using the contact information found here <https://drivenasa.com/staff-directory/>.

The Chief Executive Officer shall make every effort to ensure that fairness and justice is served. He will administer the case holding these two qualities in higher regard than any other factor. In this light, he shall not be confined by any NASA regulations, whether Regional or National, and only restricted by outside contract and by applicable laws, as set forth in CCR Section #[2.3.1](#)

17.6 Bad Faith Protests

Any competitor, entrant, or team member having knowledge or suspicion of illegal parts or modifications to another competitor's vehicle has an obligation to immediately disclose that information to that competitor, entrant, or team, or to the Race Director. Filing a protest in violation of these rules will cause action to be taken against the protestor. This will not however, affect the acceptance, rejection, or outcome of the protest.

RACING

17.7 Class Rule Compliance

Each competition vehicle must conform to the published set(s) of rules for its class. Any competitor found to have qualified or raced a competition vehicle found to have unauthorized modifications may be penalized. NASA Impound Inspectors will determine legality of modifications to competition vehicles. Any modification(s) to performance items, **whether it is a performance advantage or not**, will be deemed “illegal,” and subject to penalties. All illegal items become the property of NASA in their entirety. Performance items are those items that, if modified, could potentially increase performance. For example, a missing door handle would not necessarily be considered illegal, and normally, the competitor would be required to make corrections without penalties.

17.8 Minimum Weight

Each driver shall be given a standard five (5.0) pound leeway under the minimum published weight for their car during the first time (voluntary or not) the car is weighed for that event (regardless of how many days there are in the event). After the initial weighing, the competitor must meet the exact published weight with zero (0.0) pounds leeway for the remainder of that event. This policy should compensate for any discrepancies between scales, margin of error, and imperfections in ground surfaces.

RACING

18 GENERAL COMPETITION VEHICLE RULES

18.1 VEHICLE APPEARANCE

18.1.1 Car Numbers and Class Designation

The vehicle must exhibit its assigned car number and class designation on both sides, front, and rear of the car.

The side numbers must be at least ten (10) inches tall with a one and a half (1.5) inch stroke and be of a contrasting color. The front and rear numbers, and class designations must be at least three (3) inches tall. Car numbers and class designations must be legible and readable at speed. Numbers should not be part of the vehicles graphics unless permitted by the Chief of Timing and Scoring.

18.1.2 Advertisements and Graphics

Advertising and graphics may be used on the vehicles provided they are in good taste and do not interfere with the required identification marks or conflict with any series' sponsors. All competition vehicles are required to prominently display at least four official NASA decals: one (1) on the front of the car, and one (1) on each side and one (1) on the rear. This applies to all race classes, except certain guest groups, and any other race classes designated by the Regional Director. Official decals can only be obtained from the NASA local region or NASA merchandise vendors.

18.1.3 Car Condition

All competition vehicles look in good condition. Excessive body damage, primered body panels, etc., is prohibited. The competition vehicles must meet the "50/50" rule that means they must look undamaged and straight at fifty (50) mph from fifty (50) feet. Only the Race Director, Executive Director, Regional Director, or the race promoter may grant exceptions to this rule.

18.1.4 Loss of bodywork

All major body components such as hood, trunk, doors, etc. shall be maintained in normal position during all on track activities. If loss of bodywork is a hazard, the vehicle may be black-flagged. A vehicle completing a race with missing bodywork may be penalized. The vehicle must also meet the required minimum weight after qualifying or racing as weighed without the missing body part. Competitors may pit to replace missing parts or add weight during the race, providing all other rules are followed. Adding weight to replace a part may satisfy weight requirements however may not be legal in class rules.

18.2 Mufflers: Sound Limit.

There may be a specified sound limit for each event. For the purposes of this section the term "Black Flag" refers to either a standard Black Flag, or a Mechanical Black Flag. A vehicle measured to be over the sound limit will be Black Flagged. The Black Flagged driver must pit immediately. Failure to pit immediately when given the Black Flag for a sound violation will carry extremely severe penalties, typically a fine of five hundred (500) dollars. The vehicle will not be allowed on the racetrack until significant changes are made to make the vehicle quieter. The following rules apply to all events unless otherwise specified: *[A car Black Flagged for excessive noise two (2) times during the same event shall be excluded from the event. No car shall be re-included unless specifically permitted by the Event Director. A bonafide mechanical failure of the muffler/exhaust system will not be held against the driver; however, it must be satisfactorily fixed before further on track participation is allowed.]*

Drivers should note that different venues may measure sound differently and things such as surrounding buildings, walls, measuring distance, etc., may give a higher or lower reading than expected. All drivers are responsible for meeting the sound limit requirements of the venue.

RACING

18.3 Permitted Fuel

Permitted fuel is any grade of commercially available unmodified gasoline, E85 Ethanol, biodiesel, or diesel. The driver must notify the Race Director if using methanol or other exotic fuel, when class rules permit. Vehicles that run on (all or in part) electricity, propane, or hydrogen must be cleared through the National Office in writing.

18.3.1 Fuel Additives

No fuel additives are allowed unless specifically allowed by the class rules.

18.4 Engine Paint and Coatings

Engine painting is allowed, provided that it is applied to external surfaces only. No painting or coatings to any internal surfaces, such as drive train parts, blocks, manifolds, etc. is allowed, unless specifically allowed by class rules.

18.5 Battery

The battery should be securely fastened to the car. No Bungee cords or rubber cords may be used to function as the sole hold down mechanism. An electrically non-conductive material must cover the positive battery terminal. Any battery located inside the driver's compartment shall be fully covered and firmly secured to the chassis in a marine type battery case. True dry cell and AGM type batteries may be mounted without a surrounding case. Lithium ion batteries must be outside of the passenger area of the vehicle. Note- a ruptured lithium ion battery is subject to instant ignition at such high temperatures, the owner/ builder runs the risk of the entire vehicle being consumed by the fire.

18.6 Exposed Wires

No live (hot) wires may be exposed anywhere in, on, or under the vehicle.

18.7 Tire Grooving / Shaving

Tire shaving is allowed, providing that it doesn't alter the factory tread pattern. Tire grooving is not allowed.

18.8 Objects Interfering with Safe Operation

There should be no objects, including wiring, inside the driver's compartment that might interfere with the safe operation of the vehicle.

19 FLAGS, SIGNALS, AND COMMUNICATION

19.1 Purpose and Methods

Course Officials (Flaggers) are stationed around the course in various locations to provide communication in order to serve two main functions. First, they communicate information to the drivers on course. Second, they provide communication about the status of their assigned area to the Chief of Communications.

The information in this section is critical, and each driver shall be held responsible for understanding every item found in this section. Failure to instantly evaluate any given signal and / or react to it properly and with good judgment may result in severely undesirable consequences.

19.2 Signal (i.e. flag) Categories

There are five categories of flags. Any given flag can fit into any one or more of the following categories.

1. **Global** signals provide information about the entire course and/or the status of the session.
2. **Local** signals provide information about the conditions that pertain to a particular section of track.
3. **Personal** signals provide information that is specifically meant for a particular driver only.
4. **Command** signals dictate an order to follow the applicable procedures listed in this section, and immediate compliance is mandated. Certain Command signals may also provide some advisory information, in addition to issuing a mandatory order. This is a side benefit.
5. **Advisory** signals provide useful information.

19.3 Flag Descriptions and Meanings

19.3.1 Green Flag



Categories: Advisory; Global.

Description: Solid green, waving, usually only displayed at or near the starting line, as designated by the markings at the facility. This location may be changed at the discretion of the Race Director.

Uses: Functions to advise that the session has begun. This flag pertains to the condition of the entire course at the time that it is being displayed. Local condition/command flags may be displayed with it. Note- There are occasions when the track is globally green, however some passing restrictions may apply [Ref:(20.13.1)].

19.3.2 Restart Flags



Categories: Command; Global

Description: One solid motionless yellow flag and one solid motionless red flag.

Uses: Used to indicate that the start has been aborted despite the field receiving the green flag. **This flag command can only be used on the first lap.** If the start was not properly executed, or there was a miscue in a split start, all manned flag stations will display one red flag and one yellow flag to together. This is a global command ordering all drivers to cease racing, slow down, and realign themselves in the original starting order, and prepare for a restart. This means that passing is allowed and is usually necessary to regain the original starting positions. Scrubbing tires is prohibited during this reformation lap. Drivers must be reordered and prepared for the green flag the next time through Start/Finish.

RACING

19.3.3 Checkered Flag



Categories: Command.

Description: A pattern of alternating black and white squares. The pattern resembles a “checkered board.”

Uses: Functions to inform the drivers that session is over. This flag is not global because, the drivers that have not passed by this flag are driving under “Green Flag” conditions. Command: Drivers are to continue cautiously for the remainder of the lap and exit the track via pit lane. Passing after the Checkered Flag may be done if necessary, however the passing rules remain in effect, and drivers must use caution.

19.3.4 Yellow Flag - Standing



Categories: Command; Advisory; Local.

Description: A solid motionless yellow flag, displayed at any flag station(s) found anywhere around the course.

Uses: This is used locally, to advise drivers that a hazard is close; and is usually displayed at one or more of the flag stations just before reaching a Waving Yellow. Command: Drivers shall **SLOW THEIR VEHICLES** in preparation for any evasive maneuvers that may be necessary to avoid a potential hazard. **Passing is prohibited until completely past the incident, or until past next manned flag station that is not displaying any Yellow Flag(s), whichever comes first.** [Note: If this flag is displayed to indicate a hazard on, or near the course, it may be rescinded after two (2) laps even if the hazard remains]

19.3.5 Yellow Flag - Waving



Categories: Command; Advisory; Local.

Description: A solid waving yellow flag, displayed at a flag station(s) found anywhere around the course.

Uses: This is used locally, to advise drivers that there is extreme danger in the immediate area. Command: Drivers shall **SIGNIFICANTLY SLOW THEIR VEHICLES** in preparation for any necessary evasive maneuvers or coming to a complete stop to avoid a collision with a potential hazard. **NO PASSING is permitted, until completely past the incident, or until past the next manned flag station that is not displaying any Yellow Flag(s), whichever comes first.** [Note: If this flag is displayed to indicate a hazard on, or near the course, it may be rescinded after two (2) laps even if the hazard remains.]

19.3.6 Double Yellow Flags



Categories: Command; Global.

Description: Two (2) solid motionless yellow flags, displayed at every manned flag station around the course.

Uses: Passing is prohibited. This is used to indicate “a full course yellow.” This means that there might be a problem somewhere on the track. Drivers are NOT required to significantly slow their vehicles; however, they should be prepared to encounter a “local Yellow Flag” situation and/or a Pace Car (or a very slow-moving pack behind the Pace Car). The display of Double Yellow Flags does not guarantee the appearance of a Pace Car. It is a command that passing is prohibited until the Pace Car has pulled off the course (if applicable) and the driver has passed the next manned flag station that is not displaying any Yellow Flag(s). Reference Pace Car [Ref:(19.4.1)], [Ref:(20.12)], and [Ref:(20.13.1)]

19.3.7 Black Flag - Open



Categories: Command; Personal.

Description: Solid black and usually displayed motionless, although sometimes waved in special cases when needed. It may be displayed at any location around the course and is sometimes accompanied by a sign indicating the car number of the intended driver or a Course Official may point at the intended driver.

Uses: This flag is a strict command, displayed to a particular driver, ordering them to enter the pit lane the next time by. Additionally, it is also required that the driver report immediately and directly to the “Black Flag Station” (located in pit lane). If there is no “Black Flag Station” present or specified, the driver will report to the Re-Entry Marshal, located at the head of the pit lane.

RACING

19.3.8 Black Flag - Furled

Categories: Advisory; Personal.

Description: Solid black and “furled,” which means “rolled up” and pointed, or shaken, at an intended driver. It may be displayed at any location around the course and is sometimes accompanied by a sign indicating the car number of the intended driver.

Uses: This flag is advisory only. It is displayed to a particular driver as a warning from the Officials. This is done when the Officials have determined that a driver has committed a slight infraction or is driving in a dangerous manner. It also implies that if the infraction, or dangerous driving occurs again, the driver will receive an “Open Black Flag.”



19.3.9 Black Flag All - Waving

Categories: Command; Global.

Description: A waving solid black flag will be displayed all manned flag stations around the course. Additionally, some stations will display a sign with the word “ALL.”

Uses: This means that the session has been stopped, drivers should slow their vehicles, and passing is prohibited. This flag is a strict command, displayed (globally) to all drivers, ordering them to proceed to the pit lane at a reduced speed. Drivers must be aware that they may encounter hazards somewhere on the course. The local Yellow Flags shall still be in effect where hazards exist. Drivers may return to the paddock or they may choose to remain in the pit lane for further instructions. Whenever a session has been halted there may be a chance that it will be restarted.



ALL

19.3.10 Red Flag

Categories: Command; Global.

Description: A solid red flag will be displayed at all manned flag stations around the course. [Note: The Red Flag is meant to be used “Standing” (motionless), however it may be waved at the drivers to indicate urgency. Additionally, under unusual circumstances the red flag may be displayed at only one flag station.

Uses: This means that the session has been stopped. Passing is prohibited., This flag is a strict command, displayed (globally) to all drivers, ordering them to come a stop on the side of the track and in view of the next manned flag station.



Drivers that enter the pit lane during a red flag are prohibited from allowing or performing any work to be done on their cars, and they will be sent out at the end of pack during a restart. If more than one competitor enters the pits during a race under the Red Flag condition, the competitors shall be sent to the back of pack in order of “first-come, first-serve” lining up at Re-Entry to the track.

19.3.11 Blue Flag

Categories: Advisory; Personal.

Description: A blue flag with a yellow diagonal stripe, that can be displayed from any manned flag station around the course.

Uses: This is a personal advisory to alert a particular driver that another vehicle is following very closely or closing in rapidly and may attempt a pass. Occasionally, the Blue Flag may be waved to indicate urgency because another car is closing in from behind at a high rate of speed.



19.3.12 Debris Flag / Surface Flag

Categories: Advisory; Local.

Description: A motionless flag with yellow and red horizontal or vertical stripes, that can be displayed from any

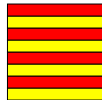

RACING

station around the course.

Uses: This is a local condition advisory that indicates a slippery surface exists (e.g. oil), or debris may be present on the track surface. Caution is advised. [Note: If debris is large, heavy, in the racing line, and/or otherwise presents itself as a hazard that will cause significant damage to a car, a yellow flag should be used along with, or in place of, the Debris Flag. This flag may be taken down after several laps, but that does not mean that the condition has resolved, just that the driver should now be taking it into account.

19.3.13 White Flag- Standing



Categories: Advisory, Local.

Description: A motionless solid white flag that can be displayed from any manned flag station around the course.

Uses: This is a local advisory flag advising the drivers that there is a slow-moving vehicle on course.

19.3.14 White Flag- Waving

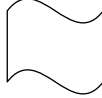

Categories: Advisory, Global.

Description: A waving solid white flag that is only displayed by the Starter that shall serve notice to the drivers that the checkered flag shall appear the next time he/she passes the start / finish.

19.3.15 Emergency Vehicle Flag

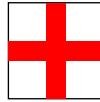

Categories: Advisory, Local, Global (at S/F)

Description: A motionless white flag with a red cross that can be displayed from any manned flag station around the course.

Uses: When encountered on course, this is a local advisory flag advising the drivers that there is an emergency vehicle(s) on course.

19.3.16 Emergency Scene

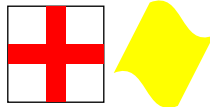

Categories: Command, Local

Description: A motionless white flag with a red cross accompanied by a waving yellow flag; that can be displayed from any manned flag station around the course.

Uses: When encountered on course, drivers shall slow their vehicles to an extreme measure, being prepared to stop; and maintain such caution until past the emergency area. This combination of flags could be deemed the most important signal in terms of the safety of the Emergency Response Team (ERT) members that have their feet on the ground, assisting a fellow driver. This signal condition should be most highly respected. It is also a command that the driver attempt to acknowledge the ERT members on the ground, with a simple gesture, while passing by the scene. This provides two-way communication, as well as a comfort level between those with the feet on the ground and those with their feet on the pedals. Failure to adhere to any part of this section shall be met with most severe penalties, including ejection from NASA.

19.3.17 Mechanical Black Flag



Categories: Command; Advisory; Personal.

Description: (*a.k.a. meatball flag*) A motionless black flag with an orange ball in center. It may be displayed at any location around the course and is sometimes accompanied by a sign indicating the car number of the intended driver.

Uses: This flag is a strict command, displayed to a particular driver, advising them that there is something mechanically wrong with their car, and ordering them to reduce speed and to enter the pit lane the next time by.

19.3.18 Green Flag with Waving Yellow

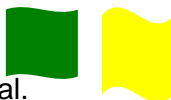

Categories: Global + Command; Advisory; Local.

Description: The starter's stand may display this combination of flags.

RACING

Uses: During a start/restart, if there is an incident requiring a waving yellow from the starter's stand, drivers may encounter this combination of flags. In a case requiring this combination of flags, all passes must be completed before the starter's stand. In the case where vehicles are side by side (any overlap) from the double file start the vehicle with the higher numbered grid spot will yield to the vehicle with the lower numbered grid spot in order to move past the incident in single file.

19.4 Lights and Meanings

19.4.1 Pace Car / Safety Car (with lights on)



The terms "Safety Car" and "Pace Car" are used interchangeably. The Pace Car may be dispatched in the middle of a session due to any number of causes, however there is only one common purpose. The Pace Car functions to collect the field of cars and slow them to a pace deemed reasonable by Control, given the circumstances. When the Pace Car is on course, the drivers shall follow it at the same speed. Those not in sight of the pace car shall close up the pack behind the pace car. They should do this at a subdued race speed, being constantly aware of local flag conditions. Passing the Pace Car is not permitted unless motioned to do so from the personnel in the Pace Car.

19.4.2 Director or Administration (lights on or off)



Any non-emergency vehicle on course displaying only flashing red lights, regardless of markings on the vehicle, is a Director, Management, or Administrator, may be treated as any other race vehicle. Drivers of these vehicles should operate as to minimize effect on the session.

19.4.3 Tow, Safety, and Fire Trucks



OR



When a driver encounters a Tow, Safety, or Fire Truck on course, he/she may pass it with due care.

19.4.4 Course Lights

Course lights are sometimes used in road course events. A blinking light is equivalent to a waving flag. A solid light is equivalent to a standing flag.

19.5 HAND SIGNALS

19.5.1 Slowing Down - driver

Whenever a driver is entering the pits or is no longer driving at normal traffic speed, he/she must extend his/her arm with hand in vertical position and fingertips towards the sky. If the vehicle does not permit this signal (e.g. NP01), the driver may intermittently tap the brakes so as to activate the brake light(s) in a flashing manner.

19.5.2 Passing Signals - driver

To assist another driver in overtaking, hand signals should be used whenever possible. The driver may do this by pointing to the side he/she expects to be passed on in such a fashion that is visible to the overtaking driver. Directional signal shall not be used to assist in passing.

19.5.3 Flag Station Acknowledgment

All drivers shall give a wave of acknowledgement to every manned turn station during the cool down lap.

19.5.4 Other Hand Signals - driver

For safety reasons, hand signals not listed above are not acceptable. Displaying the middle finger to another driver or official will be considered unsportsmanlike conduct.

| |
|-----------------------|
| One Minute |
|-----------------------|

19.6 Sign Boards

Signboards are another way communicating to the drivers. Typically, signboards are displayed on grid, pre-grid, and/or in the pit lane indicating five (5), three (3), & one (1) minutes before the start or resumption of the sessions. Each region, event, and/or organization has their own set of signs for different reasons. Some of these signs include “Deer,” indicating that there are deer near the course. There are many other signs as well, and it is up to the diligent driver that is new to each organization to learn the pertinent signs being used and what they mean.

19.6.1 Leading Vehicle Pace Car

| |
|----------|
| PACE CAR |
|----------|

| |
|-----|
| 6 7 |
|-----|

During a full course yellow condition, the driver in the overall lead is expected to slow down and essentially function as a Pace Car, until such a time as the Pace Car can properly pick up the lead. To assist the leading driver in determining when he/she is expected to temporarily function as a pace car, a number board displaying their vehicle number will be displayed at some point along the course, accompanied by a sign displaying the phrase “PACE CAR.” or “SAFETY CAR.”

RACING

20 COMPETITION FORMAT

20.1 Race Length

The race sessions may vary at each event. It is the competitor's responsibility to ascertain the race length by information from the Officials. A race may be shortened or stopped at the discretion of the Director. If a race is stopped with less than fifty (50%) percent of the total specified time (or total specified distance, when applicable) completed by the overall leader, and the race is not restarted, it shall be deemed an incomplete race. An incomplete race will be not counted, and no points or prizes will be awarded. If a race is stopped after the overall leader has completed fifty (50%) percent, or more, of the total specified time (or total specified distance, as applicable), and the race is not restarted, the race shall be deemed completed. A shortened, but complete, race shall be scored at the finish line, in order of the last lap before the race was stopped. However, there is an exception. The Regional Director may override this rule, all or in part.

20.2 Qualifying and Starting Order

Qualifying shall be optional at the discretion of the Race Director.

20.2.1 Random Grid / Special Cases

In the case where no qualifying is scheduled, or no qualifying results are available, the Race Director may order a random grid. A random grid will be determined by a method selected by the Race Director

20.2.2 Grid Adjustments, Inverts, Draws, etc.

The Race Director reserves the right to make reasonable adjustments in the grid order to correct mistakes, or to ensure fairness. The Race Director also reserves the right to invert the grid, all or in part, or mandate that the top qualifiers draw for grid. It is the competitor's responsibility to know his/her position on the grid.

20.2.3 Lack of Qualifying Times

If a competitor's vehicle number does not appear in the posted qualifying results or session grid, he/she must automatically start in the back of their class.

20.2.4 Teammates and Vehicle Substitutions

The same driver or his/her legal teammate must qualify the vehicle to be raced. A driver may change cars after qualifying, however he/she must start in the back of his/her class. The Race Director must approve any car change, before the start of the race.

20.3 Grid Formation

Grid formation will be formed on the track within the last two (2) corners before the Starter or when the Pace Car lights are extinguished, whichever comes first. CCR Sections #20.5.1 and #20.6 describe the details of formation.

20.3.1 Pre-Grid

Pre-Grid should be formed, as scheduled, prior to the race. Any driver failing to make it into their assigned Pre-Grid space before it is their time to proceed on track will be sent out last of all classes.**

** The competitor has the option of missing the warm up lap, in which case they may be released from the pit lane with their class, at the discretion of the Re-Entry Marshal, after the green flag has been displayed, or racing resumes. Under no circumstances, except under direct order from the Race Director, will a late car be allowed to regain their position on the pace lap.

RACING

20.3.2 Choosing the pole

The pole sitter side will by default, always go to the inside of the first turn, unless otherwise mandated or approved by the Race Director. If the pole sitter is allowed to choose the opposite side, that will only "reverse" the first row and have no effect on drivers that are 3rd or higher on the grid.

20.4 Warm-up Laps

There should be at least one (1) warm-up lap or partial lap, either with or without a Pace Car. The number of warm-up laps will usually be one (1). When the Pace Car pits the pole sitter will function as the Pace Car.

20.5 The Start

The Race Director will choose the format of the race. The start may be standing, rolling/flying, or any other format. It is the competitor's responsibility to understand the starting format.

20.5.1 Rolling Start / Flying Start

During the warm-up lap the field shall align into its proper starting rows. Starts will be two (2) abreast, unless otherwise specified. The field should come into alignment when the pace car lights go out or in the last two (2) turns before the Starter, whichever comes first. Once the pace car leaves the track, the lead car will be responsible for pacing the field at a steady pace, until the green flag is shown. [Note: Pace means "steady speed." Acceleration (or deceleration) after the pace car leaves the track, but before the green flag is displayed, is prohibited.] Should a vehicle pull off, or otherwise drop out of the formation, after the field has formed two (2) abreast, the space shall remain empty. Shifting of starting positions during this time is prohibited.

20.6 Standing Start

Grid will take place on track after the cars have left the hot pit lane. The competitors will complete the warm-up lap(s) with or without the Pace Car. Upon completion of the warm-up lap(s), the competitors will grid themselves according to the list posted showing the starting order [Ref:(20.2)]. It is the competitor's responsibility to know his/her starting grid position.

All drivers will position themselves on the track, for the standing start, and will leave at least one (1) car length space between themselves and the car in front them. The non-pole side as determined by the column to the outside of the first turn, must not line up closer to the starting line than the car in the row on the "pole side," or one (1) car length, whichever is greater.

Any car that is misaligned at the start of the race may be penalized one (1) position. Misaligned means that the car is too close to the car in front of them, or too far ahead of the "pole side" car beside them.

Any car that is mispositioned may be repositioned in the finishing order. Mispositioned means that the competitor has taken the wrong intended row position, or wrong side.

20.7 Split start

When more than one (1) class of cars share the track for the same race session, they may be gridded in the predetermined qualifying order, mixed together as one whole field, or they may be split apart. A "Split Start" is defined as gridding vehicles together by class (or sets of classes, known as a "Starting Group"), usually in the predetermined qualifying order with respect to the other cars in that Starting Group. When one Starting Group of cars is positioned in front of another Starting Group of cars, by distance, this is known as a spatial split start (or more commonly known as a "Split Start." There may or may not be a Pace Car for each Starting Group; or the

RACING

pole sitter in each Starting Group will function as a Pace Car, and be held responsible for spacing the Starting Groups. When a Split Start is used during a standing start, the Starting Groups are not spatially distanced, but they should be released in “waves” by time delayed lights or flags for each Starting Group. This is described in CCR sections 20.8 through 20.10.

20.8 Timed Split Start

The groups may be started by the starter with a green flag, or by a timing light system.

20.9 Flagman Timed Start (split or not)

The Starter will raise a furred green flag over his / her head and open it slowly. After displaying an open green flag for approximately five (5) seconds, the Starter will drop the green flag. The group of cars will leave the starting line. In the case of a second group of cars (split), the flagman will repeat the process; and again, for every subsequent group.

Once the green flag has been raised, and there is a need to abort the start, the Starter will keep the flag in the air, and slowly furl it closed, then lower it slowly with the handle held vertically. This procedure should be done with care, as not to cause a false start.

20.10 Light System Timed Start (split or not)

When applicable, there should be a three (3) colored light system used. Each light will be individually lit until all lights are on. Approximately five (5) seconds after all lights are on, all lights will go out. The absence of all the lights is the signal to start the race.

20.11 Start/ Restart Jumping

Jumping the start or restart is defined as leaving the starting/restarting position (but, with your correct group, in a split start situation) before the green flag drops. If a competitor jumps the start, he/she will be penalized at the Race Director’s discretion. Any movement after the green flag has been raised, until it is dropped, will be considered a “Jump Start.”

20.12 Pace Car procedures

In certain emergency situations, or the warm-up lap(s) of a race, a Pace Car may be used to lead the field. All cars shall stay behind the Pace Car unless a passing signal is given by the Pace Car personnel. [Ref:(19.4.1)], [Ref:(20.13.1)]

20.12.1 Pace Car Restart – General

The pace car, when used for a restart, should control the field and extinguish its light approximately two (2) turns before the restart green-flag position.

20.13 Restarts and Resumptions

Restarts and Resumptions occur when conditions change from a Full Course Yellow and/or a Pace Car situation, or a Red Flag had previously been shown. A Restart is a formal way of resuming a session described below. A Resumption is an informal continuation. Generally, a Resumption is used to continue sessions other than a race, and a Restart is used to continue a race. Competitors should understand that a race session might Restart or Resume without notice. Restarts are single file, unless otherwise mandated.

RACING

20.13.1 Full Course Yellow / Pace Car Procedures

During a Full Course Yellow, in the absence of a Pace Car anywhere on course (or after the Pace Car has pulled off the marked course), the lead car will pace (meaning steady speed) the field. Each competitor may resume passing at any time in the absence of a Pace Car being on course providing that they are completely past a manned flag station not displaying any yellow flag, or when the green flag has been displayed at the restart / starting stand / location. The presentation of a green flag is not a necessity to “resume” [Ref:(20.13)] a practice or qualifying session.

20.13.2 Red Flag

A Resumption from a Red Flag situation will constitute directions from the Officials to resume circulation around the course obeying the flags, as usual. A formal Restart from a Red Flag situation will be at the Race Director’s discretion. Normally the Race Director will order one of the following:

1. A total restart and re-grid in the original positions for a standing start.
2. A total restart and re-grid in the original positions for a rolling/flying start.
3. A total restart in original order, but single file, either standing or rolling/flying.
4. Restart cars in order of current lap or last lap; single file, rolling.

RACING

21 Scoring and Race Results

21.1 Adjustments by The Race Director

The Race Director reserves the right to make changes in rules and/or penalties to ensure fairness of all aspects of competition. He/she will make every effort to correct problem situations to the fairness of the majority before invoking penalties, in full or in part.

21.2 Race Starter

A driver must cross the starting line, under "green track conditions," with a vehicle under its own power, at some time during the race, but before the checkered flag is displayed.

21.3 Race Finisher

A driver must complete at least half the distance covered by the winning car of his/her class to be considered a race finisher. The car need not be running at the time of the checkered flag to be considered a finisher. A driver has five (5) minutes from the time that the lead car of the race took the checkered flag to complete his/her final lap.

21.4 Winner

The winner of a race is the driver that completes the prescribed number of laps first, or that completes the most laps in the prescribed time. The winning car need not be running at the end of the race.

21.5 Official Results

Race results will only become official when published as "Official Results," by the local NASA office or Officials. A competitor may dispute the accuracy of any results, unofficial or official, for up to thirty (30) days after the publication, or before one (1) week prior to the season banquet, whichever comes first.

21.6 Dead Heats

In the event of a dead heat, the Race Director may invoke some form of tie breaking system or contest. NASA's basic philosophy of competition discourages the recognition of "ties," however should the Race Director determine that the outcome shall be scored as a dead heat (tie), each driver shall be awarded full position finishing points and identical trophies. Should this be the case, all prizes and prize moneys will be split evenly between the dead heat finishers.

21.7 Lap Record

Each region may keep lap records. Lap records can only be set during sessions designated by the Race Director as a race.

21.8 Timing and Scoring Transponders

Most NASA race classes use the AMB transponder system for timing and scoring.

RACING

21.8.1 Ensuring Proper Functionality of the Transponder

The driver is responsible for the proper installation and maintenance of his/her transponder. If a competitor's car number does not appear in the posted **WARM UP** OR **PRACTICE** results, he/she must notify Timing and Scoring immediately following the posting of the results. It is very important to have the transponder installed and working properly, even for (and especially for) the first session.

21.9 Finish / Starting Line

The Finish Line and / or Starting Line and / or timing location may vary in relation to the Starter. It is the participant's responsibility to ascertain the location of the Finish Line and / or Starting Line and / or timing location for each event.

RACING

22 Calculating Season Points

22.1 Season Points System

Each Region reserves the right to set a minimum class size, if necessary. Regions reserve the right to declare a multiplicative on points races. For example, some races may be deemed “double points.”

22.1.1 Default Season Points System

Points payout per race as follows:

1st - 100, 2nd - 90, 3rd - 85, 4th - 80, 5th - 75, 6th - 70, 7th - 69, 8th - 68, 9th - 67, 10th - 66 ... and so on, subtracting one (1) point for each position after 10th. Points will be awarded per the schema listed above regardless if the driver is considered a finisher or not.

22.2 Dropping Race Scores

Season points dropping systems are controlled by each Region and may vary by series. Each Region may use any points drop system. If a Region does not publish a season points dropping system for any given class, the region will use the Default System [Ref:(22.2.1)] for that class. It is the competitor’s responsibility to check with the Region office to ascertain what system, if any shall be used.

22.2.1 Default Points Drop System

All NASA series competitors will be able to drop their lowest ten percent (10%) of all season points-scoring races, unless otherwise specified by the class rules or other NASA publications. All “zeros” in the season points will be “droppable,” including all disqualifications; with exception of disqualifications as a result of “non-compliance” or “cheating.” Competitors are able to drop the three (3) of their lowest points-scoring races, unless otherwise specified by the Regional Director, class rules, Series Leader, and/or other NASA publications.

22.3 Season Points- Tie

In the event of a tie for season points the winner will be decided upon the following criteria in this order until the tie is broken.

1. Adjusted points (counting “Drops,” if applicable)
2. Unadjusted points
3. Most 1st places
4. Most 2nd places
5. Most 3rd places
6. Most 4th places, etc
7. Average points per race
8. Head to head battles (number of times driver “A” finished ahead of driver “B” While competing in the same races.
9. Highest # of points earned for race win
10. Highest # of points earned for 2nd place, etc.

22.4 Team Formation

Endurance racing rules supersede this section for endurance team formations.

RACING

22.4.1 Intent

The intent of the NASA team rule is to allow two (2) drivers to share the costs of racing one car during a racing season.

22.4.2 Declaration

The drivers must declare the team for any series before either of the drivers has participated in their first race* of the season in that series. The declaration must be done in writing to the NASA local office. *Any driver that would like to form a team after one or more have driven in the series, may do so, however the prior points for either driver or both drivers will not be carried over to a newly formed team. In other words, a team formation may be allowed, but the team will start collecting points for that season from that moment forward.

22.4.3 Points Tally

Once the team is declared the two (2) drivers shall have their points tallied together. Either driver may qualify or race the car.

22.4.4 Restrictions

A maximum of two (2) drivers may be on a team in each NASA racing series.* Each driver may only be on one (1) team per series. If both teammates are driving in the same event, the team must specify before qualifying which vehicle represents the team entry otherwise the lowest finishing position shall earn points for the team. *Exception: CCR section #22.5, and the Endurance Racing Series Rules).

22.4.5 Privateer Runs

A driver may collect points for himself/herself, independent of his/her declared team, so long as he/she notifies the Race Director before qualifying.

22.5 Fun Runs

A driver may be allowed to participate in a race and be classified as a "fun run." A fun run will not earn any trophies, points, team points, prize money, etc. Cars must comply with ALL applicable safety rules. The Race Director must approve fun run entries before the start of the race. No lap records should be awarded to any driver or team that is participating in a fun run.

22.6 Non-Points Runs

Any driver may declare the voluntary forfeiture of his/her season points in any given race by simply notifying the Race Director before the race. This allows visiting or occasional series drivers a chance to compete for prize money, prizes, and trophies, without interfering in the season points hunt for the series regulars. This is an act of good sportsmanship. Any driver that declares "non-points" may do so for as many races as they like, including the entire season, simply by notifying the NASA office. If the driver is running "non-points," it is most beneficial to let the other drivers know, and the drivers' meeting is an excellent place to do this. All "non-points" drivers are entitled to collect everything else associated with their finishing position (if eligible), however they are subject to impound and inspection the same as anyone else, and their car must be legal. If there are doubts about legality, it is advised to check CCR section #22.5. The "non-points" driver would be listed in the results in their proper place however their points will go to the next lowest placing driver, and all the rest of the points would shift down one (1) place.

RACING

22.7 National Championship

All drivers shall be awarded regional points for their class(es) for all National Championships, up to three (3) races per event.

23 Participant Conduct

23.1 Participant Conduct - Expectations

It is expected that every participant [Ref: (1.4.4)] and driver (entrant) at a NASA sanctioned event will conduct themselves according to the highest standards of behavior and sportsmanship, particularly in their relationship with other drivers and Officials, and in a manner that shall not be detrimental to the reputation of NASA, its series, or other drivers. This rule also pertains to actions away from the track, such as posting comments on social media or forums that are in violations of this rule.

23.1.1 Good Sportsmanship

NASA considers good sportsmanship to be the very essence of the sport, and the basic foundation of any competition. Competitors are expected to hold the qualities of fairness, honesty, courtesy, and justice to be more important than the outcome of the race. Real sportsmen/women may have an intense desire to win, but not at all costs. A person that has won by cheating, or by any means less than honorable, has simply found a way to acquire a trophy, but not a victory.

23.1.2 Unsportsmanlike Conduct

Any unsportsmanlike conduct, on any scale, is not welcome at NASA events. Acts of unsportsmanlike conduct have many forms such as arguing, yelling, intimidation, aggressive physical contact, and losing without grace. Other forms are willfully using non-performance technicalities to hurt another competitor's race finish or point standings to the benefit of one's own, "sandbagging," and failing to report a mistake in scoring that benefits themselves. Use of an administrative procedure (e.g. appeal) by a driver that was not involved in an incident only to better that driver's finishing position or season points is considered unsportsmanlike conduct. No form of unsportsmanlike conduct will be tolerated at any NASA event.

23.1.3 Knowledge and Possession of the Rules

All drivers must know all of the rules, especially those pertaining to safety items. Additionally, all drivers must have the appropriate rule books in their possession or have immediate access to them at all times.

23.1.4 Meeting Attendance

All drivers are required to attend all mandatory meetings. Alternatively, drivers may send a proxy, however they are still responsible for all information given out at the drivers' meeting.

23.2 Conduct of Guests and Crew

Drivers shall, at all times, be responsible for the conduct and behavior of those accompanying them to an event such as crew, mechanics, and friends. Any offense committed by the driver's crew, mechanics, or friends will be directly chargeable to the driver. Damage to the racetrack, its surface, fencing, paddock, walls, buildings, trailers, equipment, vehicles, etc., by the driver (including his/her friends, crew, and sponsors) is the responsibility of the driver, and said driver agrees herein to make restitution. This agreement is binding for anyone that enters an event.

RACING

23.3 Medical Conditions

It is the responsibility of the driver to notify the NASA office and/or the Event Director of potential, or existing, medical problems that are not listed on the Physical Examination Form (if applicable). Any driver that has an abnormality of the heart as evidenced by an EKG and a Vector-Cardiogram may not be allowed to participate. It is the responsibility of those participants with a history of heart abnormalities, to obtain and submit specific written permission from his/her doctor to the NASA office before going on track.

23.4 Pregnant Drivers

Pregnant participants may be allowed to drive with specific approval from a medical doctor. It is the sole responsibility of the participant to abide by this rule. The NASA administration however, does not recommend driving while pregnant.

23.5 Disabled / Handicapped

NASA has built itself, and prides itself, on being very accommodating to as many people as possible. Since different NASA region host various activities at a wide variety of locations, it is impossible to maintain a consistent level of proper accommodations for the disabled. Most tracks have some accommodations for the disabled, however NASA recognizes the need for improvements at a number of facilities. Therefore, any disabled person that is planning to attend a particular event is encouraged to contact the local NASA office; and the staff will be happy to see to it that the best practical arrangements are made.

23.6 Responsibilities for Valuables

Theft is virtually unheard of at NASA events; however the management encourages all participants to lock up their valuables. Participants are strictly responsible for the safe keeping of their own belongings. The event facility management, NASA, and NASA affiliates take no responsibility for any loss, damage, or theft of any item while at the event.

23.7 Alcoholic Beverages

Consumption of alcohol by any participant [Ref:(1.4.4)] is expressly prohibited.

23.8 Narcotics and Dangerous Drugs

The use of any dangerous drugs or narcotics, as defined by Federal and/or state laws, by any driver, crewmember, mechanic, or Official is specifically prohibited, unless prescribed by a doctor. Any driver, crewmember, mechanic, or Official found under the influence of marijuana will be ejected and subject to suspension.

23.9 Rain and Inclement Weather

The event will not be canceled due to inclement weather unless ordered by the Regional Director. It is the responsibility of the driver to bring appropriate equipment such as rain tires, clothing, etc.

23.10 NASA Suit Patch

All competitors are required to wear a NASA Suit Patch on the upper torso of the front of their driving suit. The patch must be affixed in a "permanent" manner, such as stitching or iron-on.

RACING

24 Rules of the Pit lane and Paddock

24.1 Paddock Rules

1. Children must remain under close adult supervision at all times.
2. Parents shall not allow their children to play around any pets that may be at the facility unless that pet belongs to that child or parent.
3. The speed limit in the paddock is five (5) MPH for any vehicle other than emergency vehicles. This speed limit applies to motorized and non-motorized vehicles as well.
4. Entrant provided boards must be placed under loaded jack stands to avoid damage to the asphalt surface.
5. Participants are required to park in certain areas. Illegally parked vehicles will be towed at owner's expense.

24.2 Pets at the track

Some tracks prohibit pets (including dogs) and/or have special rules regarding pets. It is recommended that all pets be left at home. However, should a pet be brought to a track that allows pets, the following conditions apply: The owner is solely responsible for the actions of his/her pets. This means cleaning up after them and being held legally liable if their pets bite another pet or a human. Additionally, all pets must be kept on a leash, in a cage, or in a vehicle at all times. No pets are allowed in the pit lane at any time.

24.3 Loud Engines

Each facility has its own set of rules for allowed sound levels at all times of the day or night. It is the responsibility of the participant to check with the local NASA Office, or the facility to get this information. Typically, this information is found in either the Region's Supplementary Rules, or it is included in the acceptance letter, however this is not guaranteed. As a rule of thumb, at most tracks it is prohibited to start loud engines (even for a few seconds) before 8:00 AM or after 6:00 PM (unless the event hours exceed this time). Failure to comply with the sound rules after hours at any given facility will result in harsh penalties.

24.4 Gas Cylinders

All compressed air bottles/gas cylinders with a rated pressure of over two hundred pounds per square inch (200 PSI) must be securely fastened vertically so as not to topple over or shall be fully enclosed in a structure, such as a rollaway or crash cart. Anytime a cylinder is not secured upright or enclosed in a cart there must be a protective cage or cap around the head.

24.5 Bicycles, Skates, Moped, etc.

No one without a valid state driver's license may operate any mode of transportation in the paddock. Skates, skateboards, motorized skateboards, and in line skates are not permitted at any time. With the advent of many new ways to get around, the general rule of thumb is: if you sit on it, you can use it. No seat means no go. **PARENTS: Unless your child has a valid state driver's license, this means NO BICYCLES.**

24.5.1 Segway™

Use of the following models of Segway products is permitted: i67, e67, p133, i80, XT, i2, and x2. Additionally, use of all of the following: Ninebot S, S-PRO, and S-plus; but all must be used with optional handlebars (OEM or aftermarket).

RACING

24.6 Minimum Attire

All participants must wear at least a T-shirt, short or long pants, and shoes (no open toed shoes). Shorts in the pit lane are permitted except during sessions requiring refueling such as endurance racing. Some racetracks may have more restrictive requirements.

24.7 Overshooting the Pits

If a pit-bound driver overshoots his/her pit space, he/she must either continue back on to the track, or they may be pushed back into their spot. An Official may grant permission to back-up in the pit lane, if the situation is warranted and deemed safe. This rule does not apply to any Officials driving counter course, or backing-up, in the pit lane during the course of their duties.

24.8 Endurance racing

The rules for the pit lane during a “refueling race,” or an endurance race are vastly different than the sprint races. The pit lane rules for that activity are listed in the NASA Endurance Racing Series rulebook.

RACING

25 ON COURSE CONDUCT

(See Appendix A for diagrams)

25.1 Flag Observance

All flag rules must be obeyed.

25.2 Passengers

Passengers are not allowed in race groups, whether practice, qualifying, or racing. Exceptions may be made as superseded by class rules (i.e. Pro Rally or Rally Sprint) or Supplementary Regulations.

25.3 Rough, Careless, and Irresponsible Driving

Any driver, deemed by the Race Director, displaying rough, careless, and/or irresponsible driving may be penalized. The Race Director shall determine the course of action.

25.4 Rules for Overtaking

25.4.1 Passing General

The responsibility for the decision to pass another car, and to do it safely, rests with the overtaking driver. The overtaken driver should be aware that he/she is being passed and must not impede the pass by blocking. A driver who does not watch his/her mirrors or who appears to be blocking another car seeking a pass may be penalized. The act of passing is initiated when the trailing car's (Car A) front bumper overlaps with the lead car's (Car B) rear bumper. The act of passing is complete when Car A's rear bumper is ahead of Car B's front bumper. "NO PASSING" means a pass cannot even be initiated. Any overlap in a NO PASSING area is considered illegal.

25.4.2 Punting / Passing in Corners

The term "punting" is defined as nose to tail (or side-of-the-nose to side-of-the-tail) contact, where the leading car is significantly knocked off of the racing line. Once the trailing car has its front wheel next to the driver of the other vehicle, it is considered that the trailing car has a right to be there. And, that the leading driver must leave the trailing driver enough "racing room." In most cases, "racing room" is defined as "at least three quarters of one car width." If adequate racing room is left for the trailing car, and there is incidental contact made between the cars, the contact will be considered "side-to-side." In most cases, incidental side-to-side contact is considered to be "just a racing incident." If, in the case of side-to-side contact, one of the two cars leaves the racing surface (involuntarily) then it may still be considered "a racing incident."

25.4.3 Right to the Line

The driver in front has the right to choose any line, as long as they are not considered to be blocking. The driver in front loses the right to choose his or her line when the overtaking driver has their front wheel next to the driver. As an example, once the lead car loses the right to choose the line that driver cannot "squeeze" another vehicle off of a straight away claiming the "three-quarters of a car width."

25.4.4 Blocking

A driver may choose to protect his or her line so long as it is not considered blocking. Blocking is defined as two (2) consecutive line changes to "protect his/her line," and in doing so, impedes the vehicle that is trying to pass

RACING

with each of the two (2) consecutive movements. Drivers are encouraged to check with the Race Director for a full explanation before the start of the race.

25.5 Yellow Flag- Passing

A pass must be completed before the yellow flag station. This means that the overtaking driver must be completely in front of the overtaken car before either vehicle breaks the plane perpendicular to the track as defined by the yellow flag. Note- Drivers that attempt to “race to the yellow” to complete a pass may enter the yellow zone too fast and not under full control; and therefore, may be penalized for failing to comply with the conditions of the appropriate yellow flag rules.

25.6 Off-course Excursions

The competitor is required to follow the marked course during competition and shall not gain an advantage by an off-course excursion. An off-course excursion is defined as leaving the marked course with all four wheels. The definition of the term “advantage gained” will be left up to the sole discretion of the Race Director, and may include pass attempts that were completed, but the overtaking driver went four-wheels-off on the exit, and it was deemed to be an otherwise “ill-fated” pass (i.e. the [“Zanardi maneuver”](#)). Penalties may be assessed for an off-course excursion that affords an advantage to the offender. Those that have gone off course have a duty to reenter the course safely and give right of way to those vehicles that are on track. Reentry should be at the point that the vehicle left course, or at another location, providing that no advantage has been gained by doing so.

It is the responsibility of the driver reentering the course to yield and stay offline until back up to traffic speed. In the case of reentering the track in the middle of the pack, during a full course yellow, the driver will yield and stay offline until they match the speed of the traffic, in which case they shall merge in. While drivers may pass a reentering vehicle under full course yellow or a vehicle that is getting up to speed under full course yellow, they must not impeded the reentering vehicle while attempting to merge at traffic speeds.

25.7 Post Accident Reporting

All persons involved in any “**Significant Accidents**” are **REQUIRED** to report to the medical staff immediately. Failure to do so **WILL** result in suspension. “**Significant Accidents are:**

1. All vehicle roll-overs, regardless of damage.
2. Heavy impact rendering the vehicle inoperable.

25.8 Counter-Course Driving

Participants shall not drive on the course in the direction opposite to the normal traffic flow, unless a driver must do so for a short distance, in an extreme emergency and only for the sole purposes of getting out of harm’s way, or when ordered to do so by a Course Official.

25.9 Stopping On Course

Stopping on course is expressly prohibited unless it is an emergency event. “Stopping” includes abrupt and/or unexpected slowing to a near stop. Stopping to help a disabled car is prohibited. An emergency, for the purposes of this section, is defined as only those events concerning medical problems, mechanical failure, on-board fire, or damage from an incident that renders the vehicle unfit to continue.

RACING

25.9.1 Stopping in an Emergency

Anytime a driver is forced to stop in an emergency; the first concern should be to place the car in an area where it will not cause danger to the other drivers. When stopping off course, the driver should be careful not to stop on dry grass areas where fire can be a hazard. The crew may come to the aid of a disabled car only with the approval of the Race Director. The driver may make repairs if the vehicle is in a safe area, such as behind a wall or flag stand.

25.10 Crashes

If a driver is involved in a major crash or roll-over, the driver may exit the vehicle if it is safe to do so. The driver is responsible for determining if and when he/she should exit the vehicle. Once clear of the vehicle the driver will wait in a safe area away from the track surface and impact zones until the Emergency Response Team arrives. A driver that has exited the car may NOT walk back to the paddock. Also see CCR section #25.7.

25.11 Heating of Tires

Weaving to heat tires (a.k.a. scrubbing) is prohibited on track, except under full-course yellow conditions; and only when prudent to do so. Weaving to heat tires (a.k.a. scrubbing) is prohibited in the pitlane at all times.

RACING

26 APPENDIX A

The purpose of this appendix is to review and clarify the rules of the road as applied to NASA road racing. The following are excerpts from the NASA *Club Codes and Regulations* (CCR)

25.3 Rough, Careless, and Irresponsible Driving

Any driver, deemed by the Race Director, displaying rough driving may be penalized. The Race Director shall determine the course of action.

25.4.2 Punting / Passing in Corners

The term “punting” is defined as nose to tail (or side-of-the-nose to side-of-the-tail) contact, where the leading car is significantly knocked off of the racing line. Once the trailing car has its front wheel next to the driver of the other, it is considered that the trailing car has a right to be there. And, that the leading driver must leave the trailing driver enough “racing room.” In most cases, “racing room” is defined as “at least three quarters of one car width.” If adequate racing room is left for the trailing car, and there is incidental contact made between the cars, the contact will be considered “side-to-side.” In most cases, incidental side-to-side contact is considered to be “just a racing incident.” If, in the case of side-to-side contact, one of the two cars leaves the racing surface (involuntarily) then it may still be considered “a racing incident.” [Note: The whole intent of the “wheel next to the driver” rule is to make sure that the overtaken driver sees the overtaking car.]

Notes:

These two rules are the basis by which the Race Director will determine fault when two (2) or more cars are involved in an on-track incident. The rules described in CCR section #25.4 are intended to help drivers determine when they should attempt a pass, and who may be at fault should there be an incident. The main purpose of the “¾ car width” rule is not to allow one driver to “squeeze” the other driver. The main purpose and intent is to alert the mind of the driver that is contemplating a pass that he/she may be “forced” to go two (2) wheels off-course to avoid a collision. Basically, this means that the overtaking driver must be certain that he/she can attempt the pass with room to spare and must be prepared to take evasive action if necessary.

Note to drivers: Remember that, even though you have the “right to choose your line” it may not be smart to insist upon it. You may be involved in a collision that was not your fault, but you may end up crashing your car, sustain damage, get hurt, or at the very least be punted out of the race. The other driver may get penalties, but that will not help fix your car, get your position back, or get you out of the hospital any faster.

RACING

Description of on-track incidents:

Figure 1

Car B is attempting to pass Car A going into a left-hand corner. There is contact between the two cars at point 2. At the point of contact Car B does not have its front wheel next to the driver of Car A, and therefore does not have a right to be there. Therefore, the fault is placed on Car B.

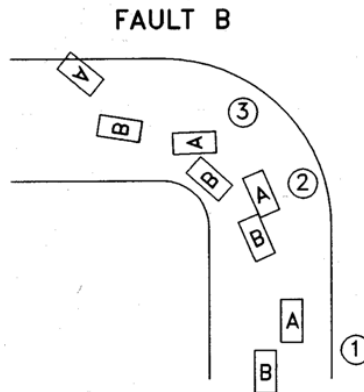

FIGURE 1

Figure 2

Car B is attempting to pass Car A going into a left-hand corner. There is contact between the two cars at point 3. Car B does have its front wheel next to the driver of Car A and therefore does have a right to be there. However, Car A leaves Car B more than enough room to make the pass. Car B has an obligation to make the pass without contact. Therefore, the fault is placed on Car B.

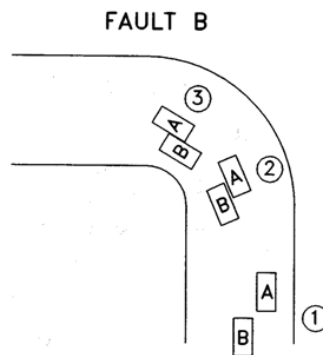

FIGURE 2

RACING

Figure 3

Car B is attempting to pass Car A going into a left-hand corner. There is contact between the two cars at point 3. Car B does have its front wheel next to the driver of Car A and therefore does have a right to be there. However, Car A does not leave Car B more than enough room to make the pass. In this case, "more than enough room" is defined as "at least $\frac{3}{4}$ of one car width." Therefore, the fault is placed on Car A.

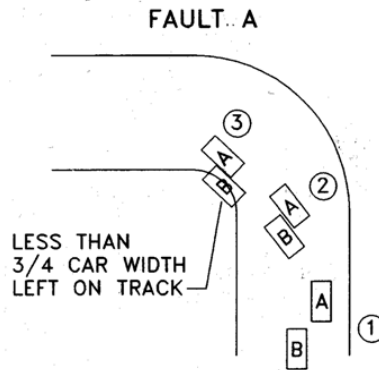

FIGURE 3

Figure 4

Car B is attempting to pass Car A going into a left-hand corner. There is contact between the two cars at point 3. Car B does have its front wheel next to the driver of Car A and therefore does have a right to be there. However, Car A leaves Car B less than one car width but more than $\frac{3}{4}$ of one car width. The driver of Car B should not have attempted to make that pass if he/she was not willing to drive into the dirt to avoid collision. The driver of Car B is at fault however he/she should report the incident to the Race Director. The Race Director should talk to the driver of Car A for not watching his/her mirrors, as well as the driver of Car B for being at fault in the incident.

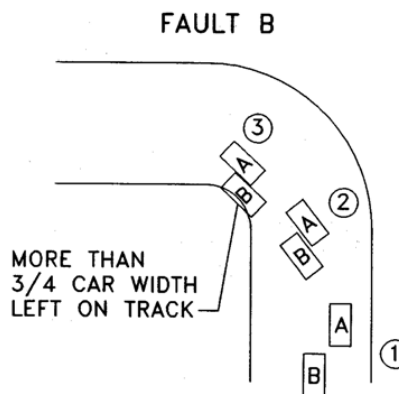

FIGURE 4

RACING

Figure 5

This is the same incident that occurred in Figure 4, however Car A is at fault for not leaving enough racing room. In most cases, $\frac{3}{4}$ of one car width would be considered barely adequate racing room. However, in this case there is "K-wall" to the inside of the corner. Common sense would tell the driver of Car A that there would definitely be a collision if less than one full car width were left for Car B.

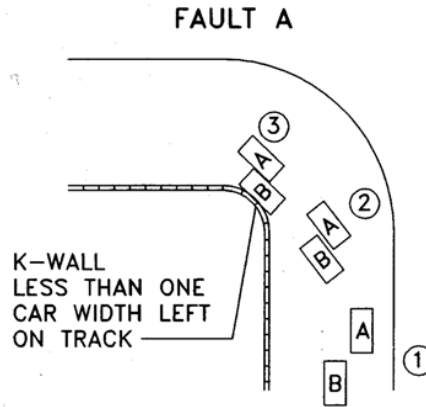

FIGURE 5

Figure 6

Car B is attempting to pass Car A going into a left-hand corner. There is contact between the two cars at point 3. Car A has already turned in and is committed to the corner. Car B attempts a last-minute pass and ends up locking up all four wheels and sliding into the side of Car A. This is a collision resulting from poor judgment and overly aggressive driving on the part of the driver of Car B.

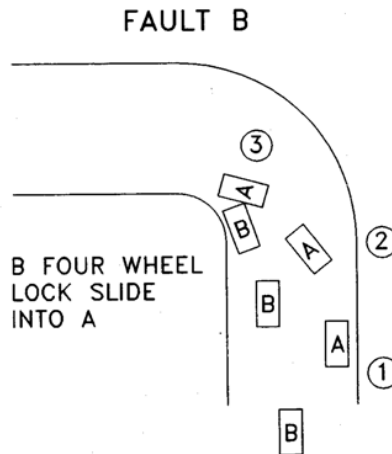

FIGURE 6

RACING

Figure 7

Car A is attempting a pass on a long straight leading to a left-hand turn. At point 2, Car A pulls alongside Car B and has a right to be there. However, by point 3 Car A falls back, where his/her front wheel is no longer alongside the driver of Car B. At point 3, Car B begins to move to the right and Car A refuses to relinquish the attempted pass. There is contact at point 4. Car A is at fault even though technically Car B hit Car A. Car A did not have his/her front wheels up even with the driver of Car B, and thus did not have a right to be there. Car B has the right to choose the line, and Car A must back out of it. Note: Car B may not be at fault in this situation, and the driver of Car A may be penalized, but Car B is still knocked out of the race. Remember that, even though you have the "right of way" it may not be smart to insist upon it.

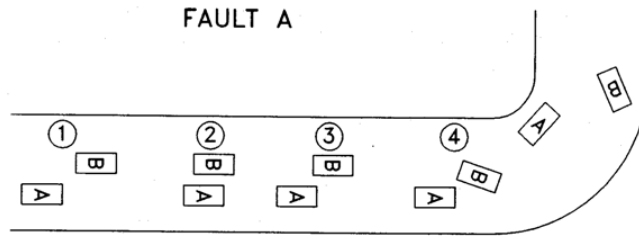

FIGURE 7

Figure 8

This is the opposite situation from Figure 7. Although the outcome is the same, the fault is reversed. Car B is attempting to make a pass. After point 4, one might assume that Car B has the right to choose his/her line as per the rules and that would mean that Car A must back out of it. However, the fault still lies with Car B. This is where things get tricky. There are two different rules that govern this situation, and it is up to the Race Director to make a determination. The first rule states that Car B has a right to choose any line because Car A no longer has a wheel next to the driver of Car B. Therefore, Car A must relinquish the lead. However, there is another rule that says that the driver that is attempting to make a pass has the responsibility to complete that pass safely. In this case the overriding rule would be the latter. That is why Car B would be at fault. Car B failed to complete a safe pass. The whole intent of the "wheel next to the door" rule is to make sure that the overtaken driver sees the overtaking car. Well in this case, the driver of Car B clearly knew that Car A was there because he/she was the one making the pass.

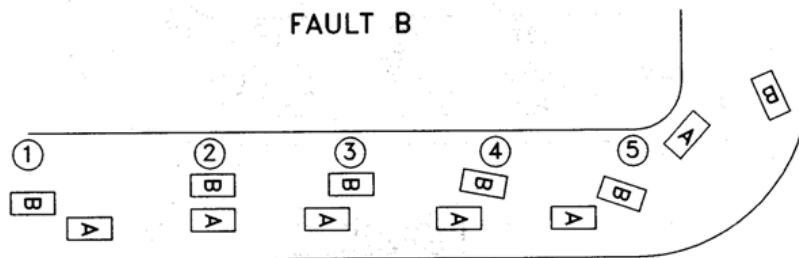

FIGURE 8

RACING

Figure 9

Car B is attempting to pass Car A on the inside of a right hand 180-degree turn. At points 3 & 4, Car B has pulled alongside Car A and clearly has a right to be there. There is no excuse for the driver of Car A not to see Car B. Therefore, fault is assigned to Car A.

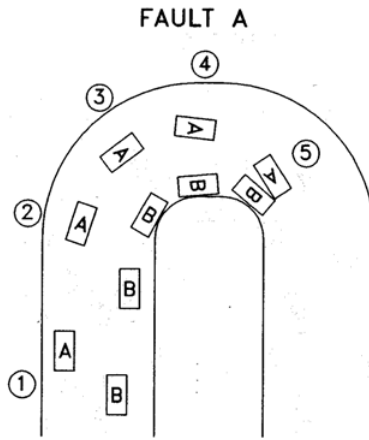

FIGURE 9

Figure 10

This is a similar situation to Figure 9, however Car A regains the lead and control of the line after point 6. Car B makes contact with the side-of-the-nose of his/her car to the side-of-the-tail of Car A, thus spinning Car A. This is clearly illegal contact as described by under section 25 On Course Conduct of the CCR. Therefore, fault is assigned to Car B.

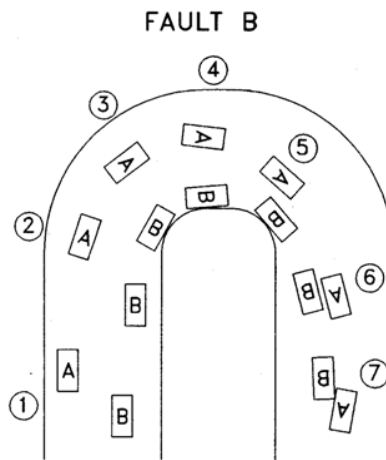

FIGURE 10

RACING

Figure 11

Car B attempts to make a pass on Car A. At Point 2, Car B now has a right to occupy that space and Car A must leave Car B racing room. Both drivers leave adequate racing room for each other. However, at Point 3 the driver of Car B loses control of the rear of his/her car. The rear of Car B makes contact with the side of Car A. This is not an uncommon occurrence, and in some circles this may be considered a racing incident. However, NASA considers the driver of Car B to be at fault for failing to properly control his/her vehicle.

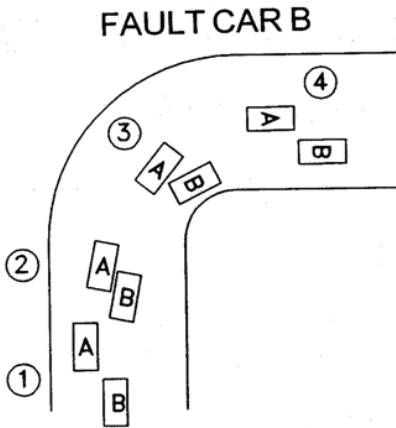

FIGURE 11

RACING

Figure 12

Car B attempts an inside pass. Car B misses the turn-in point and continues straight. The driver of Car A is expecting the pass and allows the driver of Car B plenty of room. Car A makes the assumption that Car B will turn in at the normal turn-in point. Car B does not turn in at the normal point, but Car A does, and thus Car A makes contact with Car B at Point 3. This is not an uncommon situation. Car B may have entered the turn too fast, or perhaps he/she chose not to turn in at the normal point. The turn-in point is up to each driver. The driver of Car A must not make assumptions and realize that the driver of Car B may turn in late or may never turn in at all and simply drive straight off the track. Therefore, the driver of Car A is at fault.

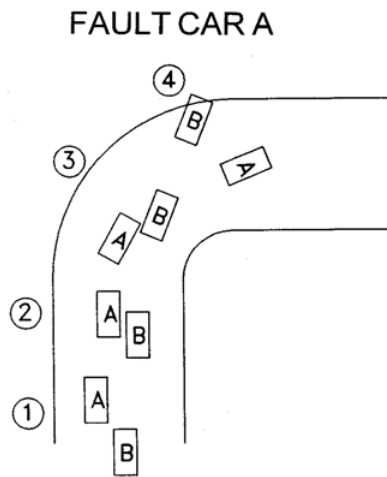

FIGURE 12

27 APPENDIX B

Body Contact and Incident Review Guidelines

27.1 Purpose and Intent

The purpose and intent of this section is to give the Race Director and competitors some guidance and understanding in determining fault in an on-track incident.

27.2 Format

The Race Director may accept forms and information from drivers and witnesses, as well as, in his/her discretion collect other evidence, and use all provided / collected data to make a determination of fault, if any.

27.3 Data Collection

If a competitor needs to collect data from another competitor or official to prove his or her case, the Race Director has the power to collect such data if deemed necessary.

27.4 Definitions

27.4.1 Body Contact

Body Contact is defined as any part of a car making physical contact with another car significant enough to cause one (1) of the cars to sustain body damage or to be significantly knocked off of the racing line. Any driver involved in body contact must go directly to impound and fill out a contact report form.

27.4.2 Damage

Damage from an incident is limited to the following definition: Any sheet metal, fiberglass, or other body material, deformity significant enough to cause the NASA Officials to enforce the "50/50 rule," thus requiring repairs. Damage to suspension or other mechanical components are not included in this definition. Damage to plastic or vinyl bumper covers, trim pieces, splitters, marker lights; and marks from tire rubs, are not considered damage for the purposes of this section.

27.4.3 Course Deviation

Course deviation is defined as: when a driver is forced to significantly deviate from the "normal" racing line as a direct result of body contact from another car. Voluntary deviation to avoid another incident is not considered "deviation" for the purposes of assessing fault.

27.5 Decision Making Process:

The following are guidelines to help the Race Director swiftly deal with the cases that are presented:

Did an incident occur?

Sometimes drivers will report a spin because they think that someone may have hit them. Or they may report something that they thought that they saw (i.e. pass under yellow). If there was no incident, the reports can be discarded.

RACING

Was there actual contact?

If not, the reports can be discarded. If so, then find out if there was any damage as defined by these guidelines. If there was not damage as defined by these guidelines then the matter may be discarded, or penalties may apply as per these guidelines.

Was a car forced to significantly deviate from the racing line?

Did one car punt another car off of the track? Did one car bump another car causing them to significantly deviate thus causing a loss of track position?

27.6 Evidence

It is up to the competitors to provide all of the evidence in presenting their case. All evidence, including witness testimony and videos must be presented to the Race Director. In most cases, written testimonies from the offending parties or witness testimonies will be submitted in impound in writing. The Race Director shall make his or her decision based on the evidence submitted, or may choose to delay the matter until more evidence can be collected.

27.7 Finding Fault

The Race Director should make use of Appendix A from the CCR to help establish fault. Race Directors should be cautioned about relying on their “racer’s instinct” to decide cases. If a driver is technically at fault, then they are at fault. The Race Director has the power to deviate from the body contact rules, however it is very important that the Race Director remain consistent when finding fault and issuing penalties. If there are mitigating circumstances that cause the Race Director to deviate from the precedence, guidelines, and rules listed in the CCR, then the Race Director should include the details of these circumstances in their explanation to the competitors. Common situations are listed below:

27.8 The Melee’

Whenever a melee’ occurs, or there is a case involving more than two drivers, try to assess the situation based on the actions of the driver that started it. When penalties are issued to the offending driver that started the melee, they should only count the original incident. The other cars that were involved are considered to be collateral damage.

27.9 The Collection

When a driver spins or otherwise loses control over his/ her vehicle, and the car(s) following that person hits the spinning car, fault can be hard to determine. In most cases, this is considered to be a racing incident. The normal highway “following too closely” law does not apply to the racetrack. Whenever a car spins out of control, it is up to the reactions and instincts of the following drivers to brake, accelerate, or swerve in order to miss the spinning car. In most cases, the following driver that fails to avoid a spinning car and/or causes more cars to become involved, should not be held liable. About the only time that any penalties are issued in this type of situation is to the driver that spun, should this driver be on probation at the time of the spin.

27.10 The Punt

Whenever a driver makes nose-to-tail (or side-of-the-nose to side-of-the tail) contact that causes the lead car to spin, or otherwise leave the course, it is considered that the trailing car “punted” the leading car. In almost all cases the trailing car is at fault and is usually disqualified. There may be some argument, in some cases, that the contact was only a light tap, and the leading driver did not have enough experience to control the slight

RACING

deviation of the back end of his car. While this may be a valid argument, this is not a valid excuse. Drivers should be reminded that even the slightest tap on the bumper of a car driven by a rookie might result in a crash.

27.10.1 The Punt (exceptions)

There can be exceptions to the punt rule. If the offending driver can prove that he/she was hit and forced into the car in front, then this may be grounds for dismissal. If it can be proven that the leading car purposely or inadvertently used his/her brakes in an area that is not a normal braking zone, this may be grounds for dismissal. However, if a driver brakes a little early going into a braking zone and there is contact and a punt results, this is not grounds for dismissal. The trailing driver should be aware that following too closely when approaching a brake area might result in contact.

27.11 Issuing Penalties

The Race Director may choose to issue any penalty for any infraction. However, it is highly recommended that he or she follow closely with what is published in the rulebook. Any deviation from what is published without due proof of mitigating circumstance may be grounds for appeal. The following is a list of suggested penalties for the listed infraction:

1. Contact bumper to bumper with no deviation and no damage: No penalty
2. Any sheet metal contact with no damage and no deviation: No penalty
3. Any contact causing deviation, with no damage, but loss of a position: Reposition
4. Any contact resulting in "damage" as defined by these guidelines: One (1) race suspension
5. Any contact resulting in a "punt" as defined by these guidelines: Disqualification
6. Any contact resulting in damage and punt: Disqualification and one (1) race suspension
7. Passing under a standing yellow or double yellow: Reposition to last place (minimum)
8. Passing under waving yellow and / or over-driving any yellow: Disqualification (minimum)

These are general guidelines for standard penalties. They may be additive or multiplicative depending on the situation and the person's past record. The Race Director may invoke more severe penalties for repeated violations.

27.12 Driver's Points System

The Race Director may elect a "Pointskeeper" for the sake of keeping track of on track violations and penalties. Because the faults and/or penalties may be appealed, no results shall be official until personally approved by the Race Director and published as Official Results. The Pointskeeper will keep a tally on the accumulation of driver's points for each driver. The following are guidelines for assigning points.

1. Contact bumper to bumper with no deviation and no damage: No points
2. Any sheet metal contact with no damage and no deviation: One (1) point each
3. Any contact causing deviation, with no damage, but loss of a position: Three (3) points for the offender, one (1) point for the other driver.
4. Any contact resulting in "damage" as defined by these guidelines: Three (3) points for the offender, one (1) point for the other driver.
5. Any contact resulting in a "punt" as defined by these guidelines: Three (3) points for the offender, one (1) point for the other driver.
6. Any contact resulting in damage and punt: Six (6) points for the offender, one (1) point for the other driver.
7. Passing under a standing yellow or double yellow: Two (2) points
8. Passing under waving yellow and/or over-driving any yellow: Six (6) points

RACING

27.12.1 Point Limit- Annual

Any driver accumulating ten (10) points during the season shall be required to appear before the Race Director, or otherwise cause a review by the Race Director and/or the Executive Director. The Race Director / Executive Director shall review the driving record of the offending driver and take appropriate action.

28 Appendix C

28.1 Definitions and References

All definitions in this section may serve one or more purposes:

- a) Clarify and define terms as applicable
- b) Define acronyms
- c) Acknowledge due trademarks and copyrights. Note: All citations referencing other organizations and/ or trademarks are simply that; a reference. NASA makes no claims to any of these marks or any copyrighted material from said entities.

28.1.1 'IMSA'

IMSA is the International Motorsports Association and is a recognized race sanctioning organization. IMSA is a registered trademark of INTERNATIONAL MOTOR SPORTS ASSOCIATION, INC. CORPORATION FLORIDA.

28.1.2 'SCCA'

SCCA is the Sports Car Club of America and is a recognized race sanctioning organization. SCCA is a registered trademark of Sports Car Club of America, Inc. Corporation Connecticut.

28.1.3 SRO

SRO Motorsports Group is a recognized race sanctioning organization.

28.1.4 'PSR'

Stands for Professional SportsCar Racing, formerly known, and currently reestablished as IMSA. [Ref: (28.1.1)]

28.1.5 'FIA'

Federation Internationale De L'Automobile is recognized as one of the worldwide leaders for setting standards in auto racing.

28.1.6 'Splitter'

Is an aerodynamic device that is attached to the front lower portion of a vehicle to essentially 'split' the air flow in a clean fashion so as to lessen turbulent air flow on the nose of the vehicle, but by forcing air to either go under the vehicle or be directed over or around the vehicle.

28.1.7 'Air Dam'

Is a device that is attached to the front lower portion of a vehicle that forces air either around or over the vehicle, or functions to capture some air so as to affect things like brake cooling systems using air.

28.1.8 'Group or Type'

As in reference to a battery refers to a universal number assigned to that size and style of battery.

28.1.9 'Wheel' / 'Tire' / 'Rim'

Unless otherwise specified and intended by the class supplemental rules, it is generally accepted that a "rim" is the round metal part that a tire mounts to. A "tire" is the rubber part that mounts to the rim. A "wheel" is considered the assembly of the rim and tire together.

28.1.10 Specified Measurement

Whenever the manufacturer *or applicable* rules do not specify a measurement, the common average measurement will be used. This common average measurement shall be determined by either 1) calculating a

RACING

mean average of at least three measurements from the corresponding parts found on other vehicles *that are chosen by the technical inspector*, or 2) the technical inspector will decide based on any other reasonable method, providing that the data, system, and logic that was used be made known to the parties involved. The second option is only permitted under circumstances where option number one becomes impractical, as determined by the series Race Director.

28.1.11 Tolerances

All published measurements infer a tolerance of +/- one-half of the last specified decimal place. All rounding will be done to the nearest decimal place that is specified by the manufacturer or these rules. In a case where a measurement falls exactly on the halfway mark, it shall be rounded up or down in favor of the competitor. This section does not apply whenever the manufacturer, or these rules, specifies a tolerance. For example, if the specification is "not more than 5 lbs.," and the equipment measures to the tenth of a pound, the reading of "5.5 lbs." would result in an official measurement of "5 lbs." The next example is when the specified measurement of "not more than 5.0 lbs." If the equipment is capable of measuring to the hundredths, then "5.05 lbs." would be rounded to "5.0 lbs."

28.1.12 Telemetry

Telemetry is defined as wireless communication of data between the vehicle and crew in either direction at any time. This includes any data which could directly be read from the ECU or sensors; and/or be used to modify any operating parameters of the vehicle, either on track or otherwise.

28.2 Disqualification "DQ"

A disqualification, unless otherwise specified, means loss of race or qualifying position. Therefore, any and all prizes, awards, trophies, contingencies, or points shall not be awarded.

28.2.1 DQ – Not Droppable

Disqualifications for vehicle non-compliance or vehicle technical infractions shall not be droppable, where applicable.

29 Appendix D

29.1 Head and Neck Restraint Systems

29.1.1 General

The SFI Foundation keeps a list of 38.1 approved devices on their website. If the device is not on this list, it will not fulfill the use mandate. As of April 1, 2012, all devices that have an SFI certification and are more than five (5) years old should be sent back to the manufacturer for recertification per SFI 38.1 specifications. There is no requirement to recertify an FIA certified device, even if it also has an SFI certification.

29.1.2 Installation and Replacement

Any systems used must be installed and used according to the manufacturer's directions. The driver is ultimately responsible for the proper installation and use of these devices. It should be noted that certain types of devices may have expiration dates and/or periodic maintenance requirements. Any device that shows signs of wear or abrasions should be sent back to the manufacturer for repair or should be replaced. "Homemade" repairs are prohibited.